

Midea 50Hz AC Fan Coil Unit 2-Pipe Wall-mounted Series Technical Service Manual(EU)

Content

1.INTRODUCTION	2
2.NOMENCLATURE.....	2
3.PRODUCT SCHEDULE	2
4.EXTERNAL APPEARANCE.....	3
5.FEATURE	3
6.SPECIFICATIONS	5
7.DIMENSIONS	9
8.SERVICE SPACES.....	10
9.WIRING DIAGRAMS	11
10.CAPACITY TABLES.....	12
11.SOUND LEVELS	27
12.EXPLODED VIEW	31
13.INSTALLATION	33
14.CONTROLLER.....	44

1. Introduction

MKG fan coil is a kind of newly designed fan coil units, which is mounted on the wall. It has two kinds of body, both have 3-way valve inside the body. In additional, it has panels of different color can be optional.

MKG series fan coil is designed and manufactured on the base of fully adoption advanced technology. The acute and thin body makes it save a lot of space and easy for installation. Quality materials and state-of-the-art technology ensure optimal performance with virtually imperceptible noise levels and keep running smoothly.

Midea MKG series fan coil unit has been tested by national AC quality supervise testing center, as low noise level, high efficiency, stable operation and low power consumption make it as the advanced production in the world,. Due to their reduced dimensions and pleasing design, these units are ideally suited for Commercial and Residential environments.

2. Nomenclature

M K G – 250 – B A

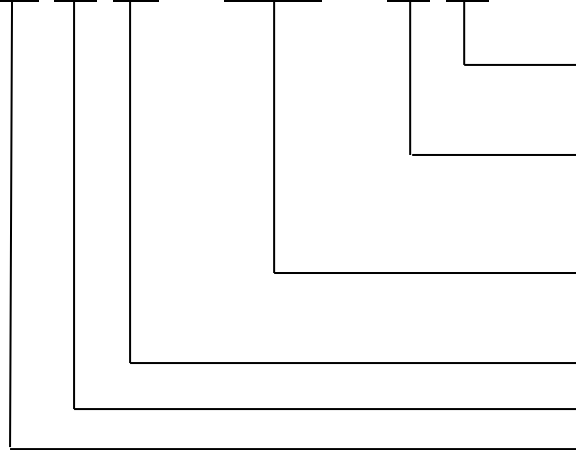

A: With Eurovent Certification
 Non: Without Eurovent Certification
Design Serial Number
Omit: C type panel
B: S type panel
Air Flow (250CFM)
Type Code
G: Wall-mounted FCU
Chilled Water Fan Coil Unit
Midea

3. Product Schedule

Series	Model	Air volume (CFM)	Power supply
C type panel	MKG-250A	250	220~240V-1Ph-50Hz
	MKG-300A	300	
	MKG-400A	400	
	MKG-500A	500	
	MKG-600A	600	
S type panel	MKG-250-BA	250	220~240V-1Ph-50Hz
	MKG-300-BA	300	
	MKG-400-BA	400	
	MKG-500-BA	500	
	MKG-600-BA	600	

4. External Appearance



C panel



S panel

5. Feature

- ◆ Multi-connection outlet pipe method: left/right/rear, more flexible for installation.

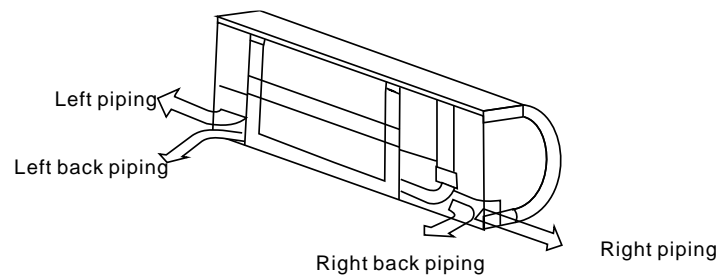

- ◆ Wind direction adjustment can be in horizontal and vertical way for auto swing louver

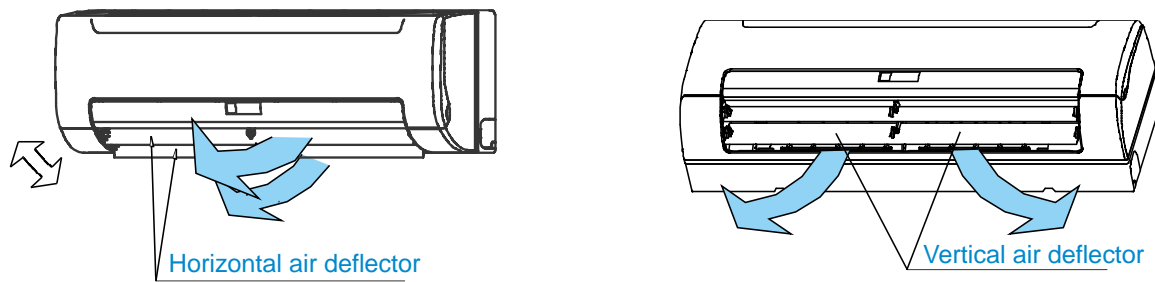

- ◆ Built-in 3-way electromagnetic valve.
- ◆ Cross flow fan creates quiet and comfortable environment.
- ◆ Easy maintenance has been realized as the front panel can be removed for easy access.

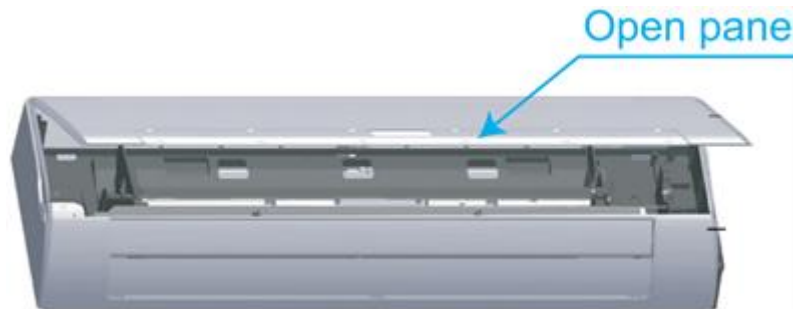

- ◆ Remote controller with LCD display is standard, wired controller and central controller are optional.
- ◆ Four-speed motor with super high speed reserved for more choice.
- ◆ Eurovent certified performance.

You can get the eurovent information of our products from: <http://www.eurovent-certification.com>



6. Specifications

Model MKG-			250A	300A	400A	
Air flow	H/M/L	m ³ /h	435/396/342	523/426/351	660/534/480	
	H/M/L	CFM	256/233/201	308/251/206	388/314/282	
Cooling	Capacity	H/M/L	kW	1.94/1.84/1.68	2.64/2.4/1.99	2.94/2.58/2.34
	Water flow rate	H/M/L	m ³ /h	0.35/0.33/0.3	0.47/0.43/0.36	0.53/0.46/0.42
	Water pressure drop	H/M/L	kPa	31.6/28.6/25.2	37.5/30/24	57.2/47.6/38.7
Heating	Capacity	H/M/L	kW	2.34/2.15/1.94	2.9/2.6/2.22	3.46/2.75/2.52
	Water flow rate	H/M/L	m ³ /h	0.43/0.39/0.35	0.53/0.47/0.4	0.63/0.5/0.46
	Water pressure drop	H/M/L	kPa	35.2/34.9/30	39.3/31.5/25	70.8/55.1/46.2
Power supply		V/Ph/Hz	220-240/1/50			
Power input	H/M/L	W	35/32/31	47/43/39	50/51/47	
Current input	H	A	0.11	0.17	0.18	
Sound pressure level	H/M/L	dB(A)	30/24/20	35/29/24	37/31/26	
Fan motor	Type		Low noise 4-speed fan motor			
	Quantity		1			
Fan	Type		Cross-flow fan			
	Quantity		1			
Coil	Row		2			
	Max. Working pressure		MPa	1.6		
	Diameter		mm	Φ7		
Body	Dimensions	W×H×D	mm	915×210×290		
	Net weight		kg	12		
	Packing	W×H×D	mm	1020×300×385		
	Gross weight		kg	16		
Pipe connection	Water inlet/outlet pipe		inch	G3/4"		
	Drain pipe		mm	ODΦ20		
Controller			R51/E (standard)			

Notes:

1. H: high fan speed; M: medium fan speed; L: low fan speed
2. Cooling Conditions: Entering Water 7°C, Temperature Rise 5°C, Entering Air Temperature 27°C DB, 19°C WB.
Heating Conditions: Entering Water 50°C, Enter air temperature 20°C, and water flow is same to the cooling conditions.
3. Noise is tested in semi-anechoic test room.

Specifications

Model MKG-				500A	600A
Air flow		H/M/L	m ³ /h	841/723/594	915/836/714
		H/M/L	CFM	495/425/349	538/492/420
Cooling	Capacity	H/M/L	kW	4.01/3.61/3.1	4.61/4.33/3.84
	Water flow rate	H/M/L	m ³ /h	0.72/0.65/0.56	0.83/0.78/0.69
	Water pressure drop	H/M/L	kPa	47.1/33.5/29.7	51/39.5/34
Heating	Capacity	H/M/L	kW	4.39/3.8/3.27	4.55/4.2/3.82
	Water flow rate	H/M/L	m ³ /h	0.8/0.69/0.6	0.83/0.76/0.69
	Water pressure drop	H/M/L	kPa	48.6/40.8/31.7	51.7/43/33
Power supply			V/Ph/Hz	220-240/1/50	
Power input		H/M/L	W	60/54/48	72/60/55
Current input		H	A	0.22	0.29
Sound pressure level		H/M/L	dB(A)	39/33/28	40/34/29
Fan motor	Type			Low noise 4-speed fan motor	
	Quantity			1	
Fan	Type			Cross-flow fan	
	Quantity			1	
Coil	Row			2	
	Max. Working pressure		MPa	1.6	
	Diameter		mm	Φ7	
Body	Dimensions	W×H×D	mm	1070×210×316	
	Net weight			kg	
	Packing	W×H×D	mm	1180×300×410	
	Gross weight			kg	
Pipe connection	Water inlet/outlet pipe		inch	G3/4"	
	Drain pipe		mm	ODΦ20	
Controller				R51/E (standard)	

Notes:

1. H: high fan speed; M: medium fan speed; L: low fan speed
2. Cooling Conditions: Entering Water 7°C, Temperature Rise 5°C, Entering Air Temperature 27°C DB, 19°C WB.
Heating Conditions: Entering Water 50°C, Enter air temperature 20°C, and water flow is same to the cooling conditions.
3. Noise is tested in semi-anechoic test room.

Specifications

Model MKG-			250-BA	300-BA	400-BA
Power supply		V/Ph/Hz	220-240/1/50		
Air flow (H/M/L)		m ³ /h	435/396/342	523/426/351	660/534/480
		CFM	256/233/201	308/251/206	388/314/282
Cooling	Capacity (H/M/L)	kW	1.94/1.84/1.68	2.64/2.4/1.99	2.94/2.58/2.34
	Water flow rate(H/M/L)	m ³ /h	0.35/0.33/0.3	0.47/0.43/0.36	0.53/0.46/0.42
	Water pressure drop(H/M/L)	kPa	31.6/28.6/25.2	37.5/30/24	57.2/47.6/38.7
Heating	Capacity (H/M/L)	kW	2.34/2.15/1.94	2.9/2.6/2.22	3.46/2.75/2.52
	Water flow rate(H/M/L)	m ³ /h	0.43/0.39/0.35	0.53/0.47/0.4	0.63/0.5/0.46
	Water pressure drop(H/M/L)	kPa	35.2/34.9/30	39.3/31.5/25	70.8/55.1/46.2
Power input (H/M/L)		W	35/32/31	47/43/39	50/51/47
Current Input		A	0.11	0.17	0.18
Sound pressure level		dB(A)	30/24/20	35/29/24	37/31/26
Fan motor	Type	Low noise 4-speed fan motor			
	Quantity		1	1	1
Fan	Type	Tangential fan			
	Quantity		1	1	1
Coil	Row		2	2	2
	Diameter	mm	Φ7	Φ7	Φ7
	Tube pitch(a)xrow pitch(b)	mm	21×13.37	21×13.37	21×13.37
	Dimension (W×H×D)	mm	635×315×26.74	635×315×26.74	635×315×26.74
	Fin spacing	mm	1.5	1.5	1.5
	Fin type	Hydrophilic aluminium			
	Circuit		5	5	5
	Max. working pressure	MPa	1.6	1.6	1.6
Body	Net dimensions (W×H×D)	mm	915×290×230	915×290×230	915×290×230
	Packing size (W×H×D)	mm	1020×390×315	1020×390×315	1020×390×315
	Net weight	kg	13	13	13.3
	Gross weight	kg	16.3	16.3	16.7
Pipe connections	Water inlet/outlet pipe	inch	G3/4	G3/4	G3/4
	Drain pipe	mm	ODΦ20	ODΦ20	ODΦ20

Notes:

1. H: high fan speed; M: medium fan speed; L: low fan speed
2. Cooling Conditions: Entering Water 7°C, Temperature Rise 5°C, Entering Air Temperature 27°C DB, 19°C WB.
Heating Conditions: Entering water 45°C, leaving water 40° C, Entering air temperature 20°C DB..
3. Noise is tested in semi-anechoic test room.

Specifications

Model MKG-			500-BA	600-BA	
Power supply		V/Ph/Hz	220-240/1/50		
Air flow (H/M/L)		m ³ /h	841/723/594	915/836/714	
		CFM	495/425/349	538/492/420	
Cooling	Capacity (H/M/L)	kW	4.01/3.61/3.1	4.61/4.33/3.84	
	Water flow rate(H/M/L)	m ³ /h	0.72/0.65/0.56	0.83/0.78/0.69	
	Water pressure drop(H/M/L)	kPa	47.1/33.5/29.7	51/39.5/34	
Heating	Capacity (H/M/L)	kW	4.39/3.8/3.27	4.55/4.2/3.82	
	Water flow rate(H/M/L)	m ³ /h	0.8/0.69/0.6	0.83/0.76/0.69	
	Water pressure drop(H/M/L)	kPa	48.6/40.8/31.7	51.7/43/33	
Power input (H/M/L)		W	60/54/48	72/60/55	
Current Input		A	0.22	0.29	
Sound pressure level		dB(A)	39/33/28	40/34/29	
Fan motor	Type		Low noise 4-speed fan motor	Low noise 4-speed fan motor	
	Quantity		1	1	
Fan	Type		Tangential fan	Tangential fan	
	Quantity		1	1	
Coil	Row		2	2	
	Diameter	mm	Φ7	Φ7	
	Tube pitch(a)xrow pitch(b)		mm	21×13.37	21×13.37
	Dimension (W×H×D)		mm	785×315×26.74	785×315×26.74
	Fin spacing		mm	1.5	1.5
	Fin type			Hydrophilic aluminium	Hydrophilic aluminium
	Circuit			5	5
	Max. working pressure		MPa	1.6	1.6
Body	Net dimensions (W×H×D)		mm	1072×315×230	1072×315×230
	Packing size (W×H×D)		mm	1180×415×315	1180×415×315
	Net weight		kg	15.8	15.8
	Gross weight		kg	19.4	19.4
Pipe connections	Water inlet/outlet pipe		inch	G3/4	G3/4
	Drain pipe		mm	ODΦ20	ODΦ20

Notes:

1. H: high fan speed; M: medium fan speed; L: low fan speed
2. Cooling Conditions: Entering Water 7°C, Temperature Rise 5°C, Entering Air Temperature 27°C DB, 19°C WB.
Heating Conditions: Entering water 45°C, leaving water 40°C, Entering air temperature 20°C DB..
3. Noise is tested in semi-anechoic test room.

Dimensions

C-panel

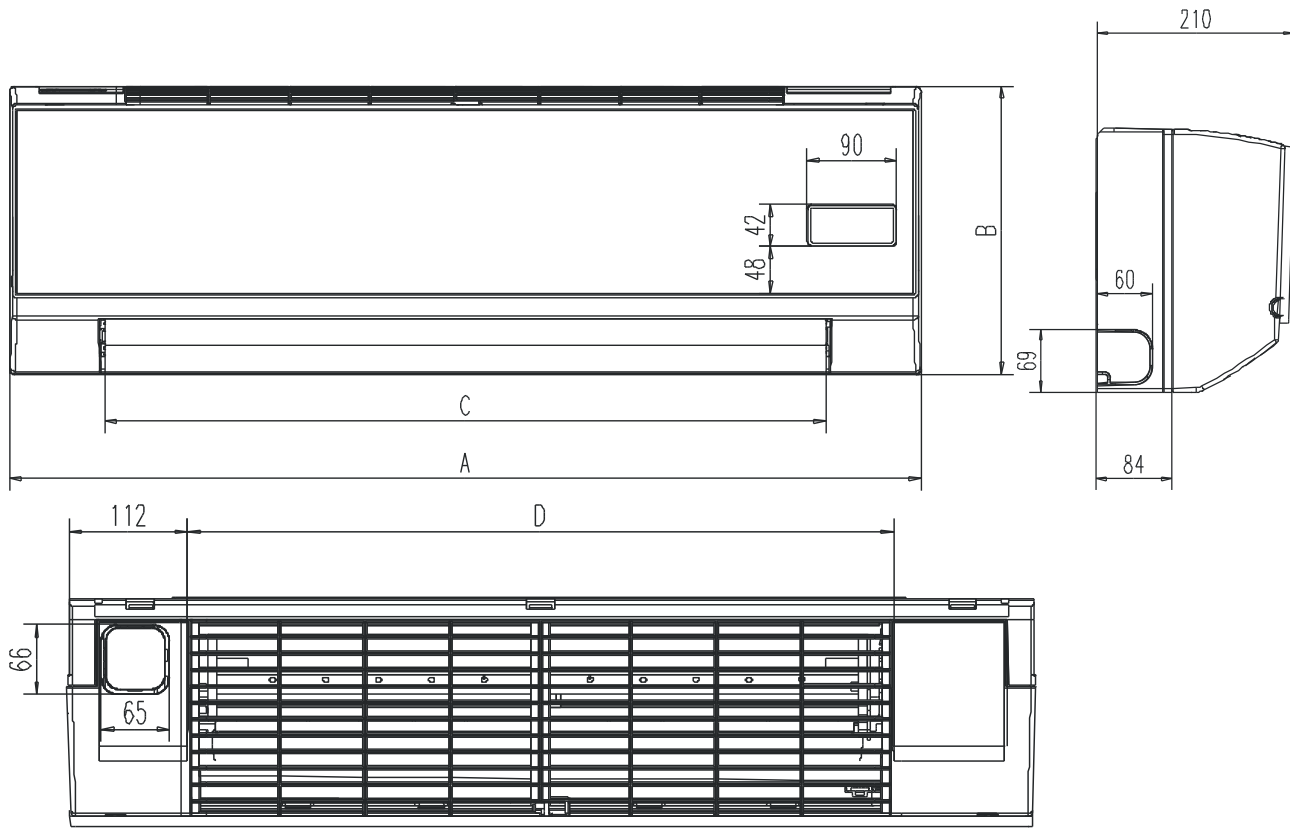

Model	MKG-250A	MKG-300A	MKG-400A	MKG-500A	MKG-600A
A	915	915	915	1070	1070
B	290	290	290	315	315
C	725	725	725	885	885
D	670	670	670	815	815

S-panel

MKG-250-BA, MKG-300-BA, MKG-400-BA

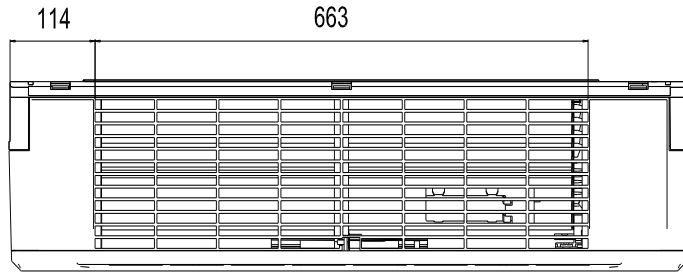
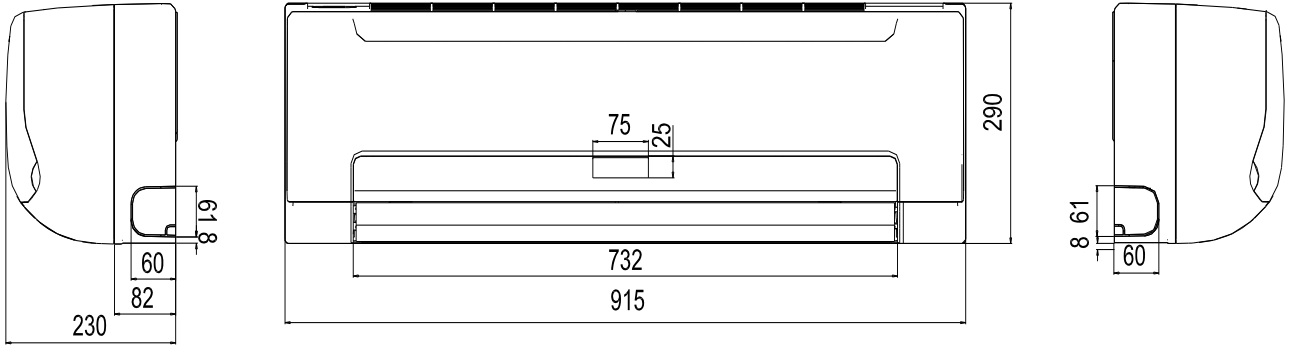

MKG-500-BA, MKG-600-BA

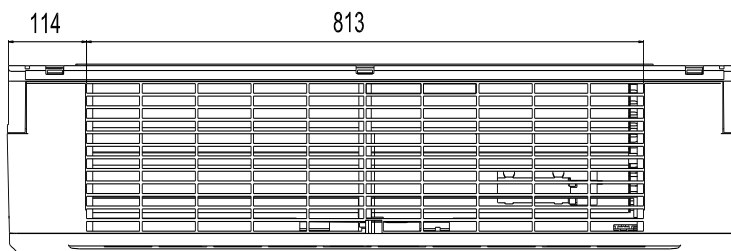
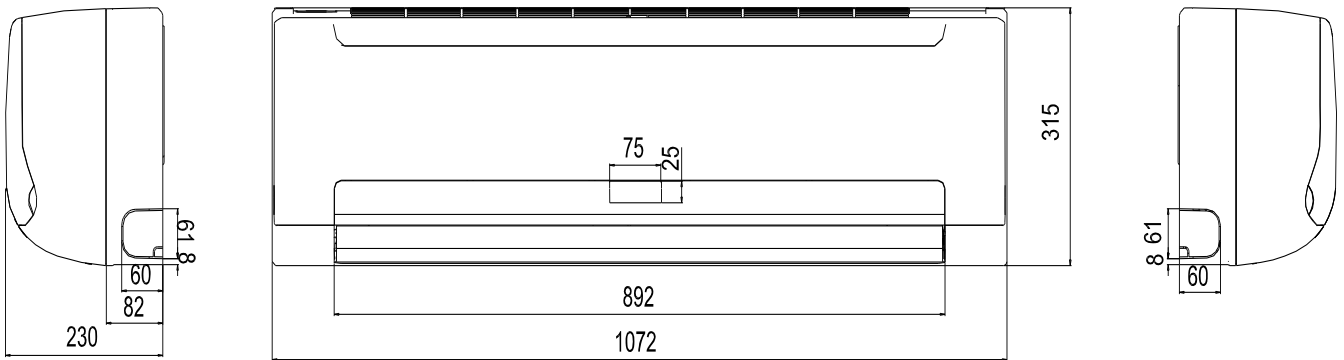

Service Spaces

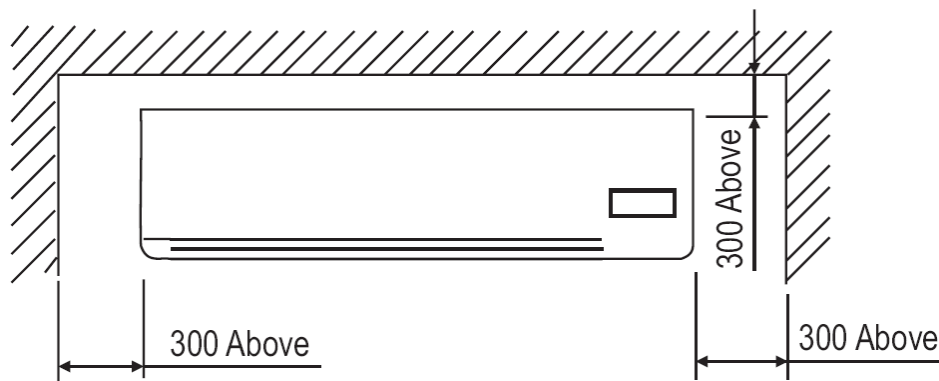

Wiring Diagrams

NOTE:

- 1.ALARM: Error codes or protections occurred , a closed signal output.
- 2.ON/OFF: Short circuit, forced off; otherwise, all the controllers available.

	0
	1

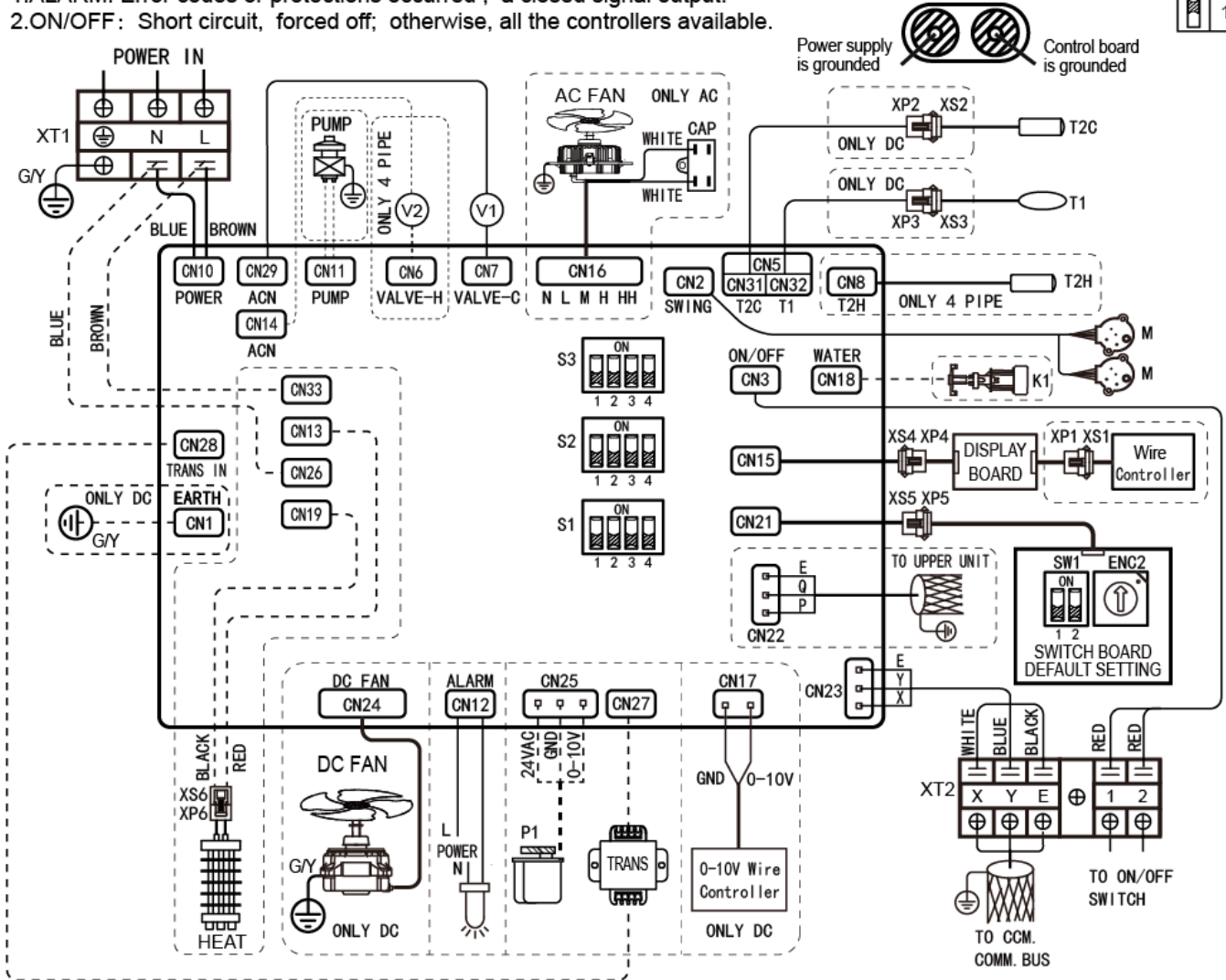

S1	S1-1		2 pipe
			4 pipe
	S1-2		Without enforcement to turn wind(default)
			With enforcement to turn wind
	S1-3		Normal anti-cold wind(default)
			High temperature anti-cold wind
	S1-4		Turn on E-heater and heating valve (default)
			Turn on E-heater, turn off heating valve

S2	S2-1/2		Temp.compensation value is 0 under cool mode(default)
			Temp.compensation value is 1 under cool mode
	S2-1/2		Temp.compensation value is 2 under cool mode
			Temp.compensation value is 3 under cool mode
	S2-3/4		Temp.compensation value is 3 under heat mode(default)
			Temp.compensation value is 1 under heat mode
			Temp.compensation value is 6 under heat mode
			Temp.compensation value is 8 under heat mode

S3		250CFM
		300CFM
		400CFM
		500CFM
		600CFM

ENC2 & SW1	SWITCH FOR ADDRESS SETTING		Address 0-15
	'0-F' of the ENC2 and 'ON/OFF' of the SW1, the different position represents a different address. Is be combined 64 address(0-63)		Address 16-31
			Address 32-47
			Address 48-63

Capacity Tables

EWT: Enter Water Temp. (°C) **Δt:** Temperature Difference (°C) **DB:** Dry Bulb Temp. (°C) **WB:** Wet Bulb Temp. (°C)
TC: Total Cooling Capacity (kW) **SC:** Sensible Cooling Capacity (kW) **WF:** Water Flow (m³/h) **WPD:** Water Pressure Drop (kPa)

MKG-250-BA/MKG-250A																						
EWT	ΔT	Indoor temp (W.B.)	Indoor temperature (D.B.)																			
			21				23				25				27				29			
°C	°C	°C	TC	SC	WF	WPD	TC	SC	WF	WPD	TC	SC	WF	WPD	TC	SC	WF	WPD	TC	SC	WF	WPD
			kW	kW	m³/h	kPa	kW	kW	m³/h	kPa	kW	kW	m³/h	kPa	kW	kW	m³/h	kPa	kW	kW	m³/h	kPa
5	3	15	1.70	1.35	0.49	16.57	1.68	1.55	0.48	16.31	1.76	1.75	0.50	17.52	1.96	1.96	0.56	21.44	2.16	2.16	0.62	25.34
		17	2.31	1.35	0.66	28.01	2.30	1.56	0.66	27.72	2.28	1.76	0.65	27.46	2.27	1.97	0.65	27.16	2.26	2.17	0.65	27.06
		19	-	-	-	-	2.95	1.56	0.85	42.73	2.94	1.77	0.84	42.33	2.92	1.97	0.84	41.95	2.91	2.18	0.84	41.86
		20	-	-	-	-	3.30	1.57	0.94	51.74	3.28	1.77	0.94	51.27	3.27	1.98	0.94	50.84	3.25	2.18	0.94	50.89
	4	15	1.44	1.23	0.31	6.48	1.46	1.44	0.31	6.71	1.64	1.64	0.35	9.07	1.84	1.84	0.39	11.53	2.04	2.04	0.44	13.87
		17	2.05	1.23	0.44	13.88	2.03	1.44	0.44	13.73	2.02	1.64	0.43	13.58	2.00	1.85	0.43	13.39	2.05	2.05	0.44	13.95
		19	-	-	-	-	2.70	1.45	0.58	22.44	2.68	1.65	0.58	22.22	2.67	1.86	0.58	22.01	2.65	2.06	0.57	21.79
		20	-	-	-	-	3.04	1.45	0.65	27.29	3.03	1.66	0.65	27.03	3.01	1.86	0.65	26.77	2.99	2.06	0.64	26.52
	5	15	1.23	1.13	0.21	2.54	1.34	1.34	0.23	2.99	1.53	1.53	0.26	4.24	1.73	1.73	0.30	5.84	1.93	1.93	0.33	7.79
		17	1.78	1.11	0.30	6.29	1.76	1.32	0.30	6.18	1.75	1.53	0.30	6.04	1.77	1.73	0.30	6.23	1.93	1.93	0.33	7.82
		19	-	-	-	-	2.42	1.33	0.42	12.58	2.41	1.53	0.41	12.45	2.39	1.74	0.41	12.31	2.38	1.94	0.41	12.18
		20	-	-	-	-	2.78	1.33	0.48	16.03	2.76	1.54	0.48	15.87	2.75	1.74	0.47	15.72	2.73	1.95	0.47	15.57
6	15	1.06	1.04	0.15	1.74	1.24	1.24	0.18	2.02	1.44	1.44	0.21	2.42	1.64	1.64	0.23	3.14	1.83	1.83	0.26	4.22	
	17	1.56	1.02	0.22	2.81	1.55	1.23	0.22	2.76	1.55	1.44	0.22	2.77	1.65	1.64	0.24	3.19	1.83	1.83	0.26	4.23	
	19	-	-	-	-	2.14	1.21	0.31	6.52	2.13	1.42	0.31	6.41	2.12	1.62	0.30	6.31	2.10	1.82	0.30	6.18	
	20	-	-	-	-	2.49	1.21	0.36	9.36	2.47	1.42	0.35	9.23	2.46	1.62	0.35	9.11	2.44	1.82	0.35	8.99	
7	3	15	1.22	1.13	0.35	9.06	1.34	1.34	0.38	10.98	1.55	1.55	0.44	14.05	1.76	1.76	0.51	17.59	1.96	1.96	0.56	20.89
		17	1.85	1.15	0.53	19.22	1.84	1.35	0.53	19.01	1.83	1.56	0.53	18.75	1.82	1.76	0.53	18.63	1.96	1.96	0.56	20.95
		19	-	-	-	-	2.50	1.36	0.72	32.05	2.48	1.56	0.72	31.73	2.47	1.77	0.71	31.41	2.45	1.97	0.71	31.11
		20	-	-	-	-	2.84	1.36	0.82	40.11	2.83	1.57	0.82	39.72	2.81	1.77	0.81	39.33	2.80	1.97	0.81	38.94
	4	15	1.05	1.04	0.23	2.90	1.23	1.23	0.27	4.47	1.43	1.43	0.31	6.71	1.64	1.64	0.35	9.24	1.84	1.84	0.40	11.61
		17	1.56	1.02	0.34	8.30	1.55	1.23	0.33	8.13	1.54	1.44	0.33	8.00	1.64	1.64	0.35	9.27	1.85	1.85	0.40	11.64
		19	-	-	-	-	2.22	1.24	0.48	15.90	2.21	1.45	0.48	15.74	2.19	1.65	0.47	15.57	2.18	1.85	0.47	15.37
		20	-	-	-	-	2.57	1.24	0.55	20.16	2.55	1.45	0.55	19.95	2.54	1.65	0.55	19.75	2.52	1.86	0.54	19.55
	5	15	0.94	0.94	0.16	1.77	1.14	1.14	0.20	2.21	1.34	1.34	0.23	3.06	1.53	1.53	0.26	4.42	1.73	1.73	0.30	6.13
		17	1.32	0.92	0.23	2.97	1.31	1.13	0.23	2.91	1.37	1.34	0.23	3.24	1.54	1.54	0.26	4.44	1.73	1.73	0.30	6.16
		19	-	-	-	-	1.92	1.12	0.33	7.98	1.91	1.32	0.33	7.86	1.94	1.66	0.35	31.60	1.88	1.73	0.32	7.59
		20	-	-	-	-	2.28	1.12	0.39	11.19	2.26	1.33	0.39	11.06	2.25	1.54	0.39	10.94	2.23	1.74	0.38	10.81
6	15	0.84	0.84	0.12	1.29	1.04	1.04	0.15	1.61	1.24	1.24	0.18	1.93	1.44	1.44	0.21	2.42	1.63	1.63	0.24	3.29	
	17	1.07	0.83	0.15	1.65	1.11	1.04	0.16	1.72	1.24	1.24	0.18	1.94	1.44	1.44	0.21	2.43	1.64	1.64	0.24	3.30	
	19	-	-	-	-	1.67	1.02	0.24	3.50	1.66	1.23	0.24	3.42	1.65	1.43	0.24	3.37	1.69	1.64	0.24	3.62	
	20	-	-	-	-	1.98	1.01	0.28	5.51	1.97	1.22	0.28	5.42	1.96	1.42	0.28	5.32	1.94	1.63	0.28	5.20	
9	3	15	0.93	0.93	0.27	4.66	1.14	1.14	0.33	7.81	1.34	1.34	0.39	10.86	1.55	1.55	0.45	13.83	1.76	1.76	0.51	17.18
		17	1.34	0.93	0.39	10.83	1.33	1.14	0.38	10.62	1.36	1.35	0.39	11.05	1.55	1.55	0.45	13.87	1.76	1.76	0.51	17.23
		19	-	-	-	-	2.00	1.15	0.57	21.24	1.98	1.35	0.57	21.00	1.97	1.56	0.57	20.75	1.95	1.76	0.56	20.44
		20	-	-	-	-	2.35	1.15	0.68	28.46	2.34	1.36	0.68	28.16	2.32	1.57	0.67	27.87	2.31	1.77	0.67	27.57
	4	15	0.84	0.84	0.18	1.92	1.04	1.04	0.22	2.93	1.23	1.23	0.27	4.62	1.43	1.43	0.31	6.89	1.64	1.64	0.35	9.23
		17	1.07	0.83	0.23	3.20	1.09	1.04	0.24	3.34	1.23	1.23	0.27	4.64	1.44	1.44	0.31	6.92	1.64	1.64	0.35	9.26
		19	-	-	-	-	1.70	1.03	0.36	9.82	1.68	1.24	0.36	9.68	1.67	1.44	0.36	9.50	1.69	1.65	0.36	9.71
		20	-	-	-	-	2.06	1.04	0.45	13.76	2.05	1.24	0.44	13.61	2.03	1.45	0.44	13.45	2.01	1.65	0.44	13.26
	5	15	0.73	0.73	0.13	1.31	0.94	0.94	0.16	1.67	1.14	1.14	0.20	2.16	1.34	1.34	0.23	3.17	1.53	1.53	0.26	4.61
		17	0.83	0.73	0.14	1.47	0.95	0.94	0.16	1.69	1.14	1.14	0.20	2.17	1.34	1.34	0.23	3.19	1.53	1.53	0.26	4.63
		19	-	-	-	-	1.41	0.92	0.24	3.70	1.40	1.13	0.24	3.60	1.41	1.34	0.24	3.72	1.54	1.54	0.26	4.65
		20	-	-	-	-	1.74	0.91	0.30	6.44	1.73	1.12	0.30	6.32	1.71	1.33	0.29	6.18	1.70	1.53	0.29	6.08
6	15	0.63	0.63	0.09	0.92	0.84	0.84	0.12	1.22	1.04	1.04	0.15	1.52	1.24	1.24	0.18	1.84	1.44	1.44	0.21	2.43	
	17	0.66	0.63	0.09	0.96	0.84	0.84	0.12	1.22	1.04	1.04	0.15	1.52	1.24	1.24	0.18	1.84	1.44	1.44	0.21	2.44	
	19	-	-	-	-	1.16	0.83	0.17	1.68	1.17	1.04	0.17	1.70	1.27	1.24	0.18	1.90	1.44	1.44	0.21	2.44	

	20	-	-	-	-	1.48	0.82	0.21	2.61	1.47	1.03	0.21	2.55	1.46	1.23	0.21	2.52	1.51	1.44	0.22	2.74
--	----	---	---	---	---	------	------	------	------	------	------	------	------	------	------	------	------	------	------	------	------

Continued:

MKG-250-BA/MKG-250A																							
EWT	ΔT	Indoor temp (W.B.)	Indoor temperature (D.B.)																				
			21				23				25				27				29				
			TC	SC	WF	WPD	TC	SC	WF	WPD	TC	SC	WF	WPD	TC	SC	WF	WPD	TC	SC	WF	WPD	
°C	°C	°C	kW	kW	m³/h	kPa	kW	kW	m³/h	kPa	kW	kW	m³/h	kPa	kW	kW	m³/h	kPa	kW	kW	m³/h	kPa	
11	3	15	0.73	0.73	0.21	2.47	0.93	0.93	0.27	4.76	1.14	1.14	0.32	7.80	1.35	1.35	0.38	10.56	1.55	1.55	0.44	13.44	
		17	0.82	0.73	0.23	3.32	0.93	0.93	0.27	4.76	1.14	1.14	0.32	7.83	1.35	1.35	0.38	10.59	1.55	1.55	0.44	13.48	
		19	-	-	-	-	1.46	0.94	0.42	12.10	1.44	1.14	0.41	11.88	1.44	1.35	0.41	11.80	1.56	1.55	0.44	13.51	
		20	-	-	-	-	1.81	0.94	0.52	17.49	1.80	1.15	0.51	17.27	1.78	1.35	0.51	17.04	1.77	1.56	0.50	16.76	
	4	15	0.63	0.63	0.13	1.35	0.84	0.84	0.18	1.83	1.03	1.03	0.22	2.95	1.23	1.23	0.26	4.75	1.43	1.43	0.31	6.97	
		17	0.64	0.63	0.14	1.38	0.84	0.84	0.18	1.83	1.04	1.04	0.22	2.96	1.23	1.23	0.26	4.77	1.44	1.44	0.31	6.99	
		19	-	-	-	-	1.15	0.82	0.25	3.90	1.14	1.03	0.24	3.88	1.24	1.24	0.27	4.83	1.44	1.44	0.31	7.02	
		20	-	-	-	-	1.49	0.82	0.32	7.54	1.47	1.03	0.32	7.38	1.46	1.23	0.31	7.21	1.48	1.44	0.32	7.50	
	5	15	0.53	0.53	0.09	0.90	0.74	0.74	0.13	1.24	0.94	0.94	0.16	1.59	1.14	1.14	0.20	2.18	1.34	1.34	0.23	3.31	
		17	0.53	0.53	0.09	0.90	0.74	0.74	0.13	1.25	0.94	0.94	0.16	1.59	1.14	1.14	0.20	2.19	1.34	1.34	0.23	3.32	
		19	-	-	-	-	0.89	0.73	0.15	1.50	0.98	0.94	0.17	1.66	1.14	1.14	0.20	2.20	1.34	1.34	0.23	3.34	
		20	-	-	-	-	1.21	0.72	0.21	2.53	1.20	0.93	0.21	2.47	1.22	1.14	0.21	2.61	1.34	1.34	0.23	3.37	
	6	15	0.43	0.43	0.06	0.59	0.64	0.64	0.09	0.88	0.84	0.84	0.12	1.16	1.04	1.04	0.15	1.44	1.24	1.24	0.18	1.80	
		17	0.43	0.43	0.06	0.59	0.64	0.64	0.09	0.88	0.84	0.84	0.12	1.16	1.04	1.04	0.15	1.44	1.24	1.24	0.18	1.80	
		19	-	-	-	-	0.69	0.63	0.10	0.95	0.84	0.84	0.12	1.17	1.04	1.04	0.15	1.45	1.25	1.25	0.18	1.81	
		20	-	-	-	-	0.92	0.62	0.13	1.27	0.95	0.84	0.14	1.31	1.07	1.05	0.15	1.48	1.25	1.25	0.18	1.81	
	13	3	15	0.53	0.53	0.15	1.46	0.73	0.73	0.21	2.61	0.93	0.93	0.27	5.05	1.14	1.14	0.33	7.93	1.35	1.35	0.39	10.54
			17	0.53	0.53	0.15	1.46	0.73	0.73	0.21	2.62	0.93	0.93	0.27	5.07	1.14	1.14	0.33	7.96	1.35	1.35	0.39	10.57
			19	-	-	-	-	0.88	0.73	0.25	4.28	0.94	0.94	0.27	5.18	1.14	1.14	0.33	7.98	1.35	1.35	0.39	10.60
			20	-	-	-	-	1.23	0.73	0.35	9.04	1.21	0.94	0.35	8.83	1.22	1.14	0.35	8.88	1.35	1.35	0.39	10.60
4		15	0.43	0.43	0.09	0.87	0.63	0.63	0.14	1.29	0.84	0.84	0.18	1.82	1.03	1.03	0.22	3.11	1.23	1.23	0.27	5.00	
		17	0.43	0.43	0.09	0.87	0.63	0.63	0.14	1.29	0.84	0.84	0.18	1.83	1.04	1.04	0.22	3.12	1.23	1.23	0.27	5.02	
		19	-	-	-	-	0.67	0.63	0.14	1.36	0.84	0.84	0.18	1.83	1.04	1.04	0.22	3.14	1.24	1.24	0.27	5.04	
		20	-	-	-	-	0.92	0.62	0.20	2.27	0.93	0.83	0.20	2.33	1.04	1.04	0.22	3.18	1.24	1.24	0.27	5.05	
5		15	0.32	0.32	0.06	0.52	0.53	0.53	0.09	0.85	0.73	0.73	0.13	1.17	0.94	0.94	0.16	1.51	1.14	1.14	0.20	2.20	
		17	0.32	0.32	0.06	0.52	0.53	0.53	0.09	0.85	0.74	0.74	0.13	1.17	0.94	0.94	0.16	1.52	1.14	1.14	0.20	2.21	
		19	-	-	-	-	0.53	0.53	0.09	0.85	0.74	0.74	0.13	1.18	0.94	0.94	0.16	1.52	1.14	1.14	0.20	2.22	
		20	-	-	-	-	0.64	0.52	0.11	1.01	0.76	0.74	0.13	1.21	0.94	0.94	0.16	1.52	1.14	1.14	0.20	2.22	
6		15	0.22	0.22	0.03	0.29	0.43	0.43	0.06	0.56	0.64	0.64	0.09	0.83	0.84	0.84	0.12	1.10	1.04	1.04	0.15	1.36	
		17	0.22	0.22	0.03	0.29	0.43	0.43	0.06	0.56	0.64	0.64	0.09	0.83	0.84	0.84	0.12	1.10	1.04	1.04	0.15	1.37	
		19	-	-	-	-	0.43	0.43	0.06	0.56	0.64	0.64	0.09	0.83	0.84	0.84	0.12	1.10	1.04	1.04	0.15	1.37	
		20	-	-	-	-	0.46	0.43	0.07	0.60	0.64	0.64	0.09	0.83	0.84	0.84	0.12	1.10	1.05	1.05	0.15	1.37	
15		3	15	0.32	0.32	0.09	0.83	0.53	0.53	0.15	1.37	0.73	0.73	0.21	2.64	0.93	0.93	0.27	5.08	1.14	1.14	0.32	7.72
			17	0.32	0.32	0.09	0.83	0.53	0.53	0.15	1.38	0.73	0.73	0.21	2.65	0.93	0.93	0.27	5.10	1.14	1.14	0.33	7.74
			19	-	-	-	-	0.53	0.52	0.15	1.38	0.73	0.73	0.21	2.66	0.93	0.93	0.27	5.13	1.14	1.14	0.33	7.76
			20	-	-	-	-	0.63	0.52	0.18	1.80	0.73	0.73	0.21	2.69	0.93	0.93	0.27	5.14	1.14	1.14	0.33	7.77
	4	15	0.22	0.22	0.05	0.42	0.43	0.43	0.09	0.82	0.63	0.63	0.14	1.22	0.83	0.83	0.18	1.81	1.03	1.03	0.22	3.17	
		17	0.22	0.22	0.05	0.42	0.43	0.43	0.09	0.82	0.63	0.63	0.14	1.22	0.84	0.84	0.18	1.81	1.03	1.03	0.22	3.18	
		19	-	-	-	-	0.43	0.43	0.09	0.82	0.63	0.63	0.14	1.22	0.84	0.84	0.18	1.82	1.03	1.03	0.22	3.20	
		20	-	-	-	-	0.44	0.43	0.09	0.85	0.63	0.63	0.14	1.22	0.84	0.84	0.18	1.82	1.04	1.04	0.22	3.20	
	5	15	0.12	0.12	0.02	0.17	0.33	0.33	0.06	0.50	0.53	0.53	0.09	0.81	0.74	0.74	0.13	1.12	0.94	0.94	0.16	1.49	
		17	0.12	0.12	0.02	0.18	0.33	0.33	0.06	0.50	0.53	0.53	0.09	0.81	0.74	0.74	0.13	1.13	0.94	0.94	0.16	1.49	
		19	-	-	-	-	0.33	0.33	0.06	0.50	0.53	0.53	0.09	0.81	0.74	0.74	0.13	1.13	0.94	0.94	0.16	1.50	
		20	-	-	-	-	0.33	0.33	0.06	0.50	0.54	0.54	0.09	0.82	0.74	0.74	0.13	1.13	0.94	0.94	0.16	1.50	
	6	15	-	-	-	-	0.22	0.22	0.03	0.28	0.43	0.43	0.06	0.54	0.64	0.64	0.09	0.80	0.84	0.84	0.12	1.05	
		17	-	-	-	-	0.22	0.22	0.03	0.28	0.43	0.43	0.06	0.54	0.64	0.64	0.09	0.80	0.84	0.84	0.12	1.05	
		19	-	-	-	-	0.23	0.23	0.03	0.28	0.43	0.43	0.06	0.54	0.64	0.64	0.09	0.80	0.84	0.84	0.12	1.05	
		20	-	-	-	-	0.23	0.23	0.03	0.28	0.43	0.43	0.06	0.54	0.64	0.64	0.09	0.80	0.84	0.84	0.12	1.05	

Cooling Capacity

MKG-300-BA/ MKG-300A																						
EWT	ΔT	Indoor temp (W.B.)	Indoor temperature (D.B.)																			
			21				23				25				27				29			
			TC	SC	WF	WPD	TC	SC	WF	WPD	TC	SC	WF	WPD	TC	SC	WF	WPD	TC	SC	WF	WPD
°C	°C	°C	kW	kW	m³/h	kPa	kW	kW	m³/h	kPa	kW	kW	m³/h	kPa	kW	kW	m³/h	kPa	kW	kW	m³/h	kPa
5	3	15	2.29	1.79	0.66	27.61	2.27	2.06	0.65	27.20	2.33	2.33	0.67	28.46	2.59	2.59	0.74	34.00	2.85	2.85	0.82	40.25
		17	3.09	1.80	0.89	46.86	3.07	2.07	0.88	45.99	3.05	2.33	0.88	45.49	3.03	2.59	0.87	44.57	3.01	2.85	0.86	44.07
		19	-	-	-	-	3.92	2.07	1.12	69.77	3.90	2.34	1.12	69.03	3.87	2.60	1.11	68.30	3.85	2.86	1.10	67.71
		20	-	-	-	-	4.37	2.08	1.25	84.38	4.34	2.34	1.25	83.52	4.32	2.61	1.24	82.69	4.29	2.87	1.23	81.84
	4	15	1.97	1.64	0.42	13.00	1.98	1.92	0.43	13.17	2.18	2.18	0.47	15.47	2.45	2.45	0.53	19.00	2.71	2.71	0.58	22.41
		17	2.78	1.66	0.60	23.29	2.76	1.92	0.59	23.02	2.74	2.19	0.59	22.73	2.72	2.45	0.58	22.44	2.76	2.71	0.59	23.04
		19	-	-	-	-	3.61	1.93	0.78	36.62	3.59	2.20	0.77	36.23	3.57	2.46	0.77	35.84	3.55	2.72	0.76	35.46
		20	-	-	-	-	4.07	1.94	0.87	44.91	4.04	2.20	0.87	44.44	4.02	2.47	0.86	43.97	3.99	2.73	0.86	43.50
	5	15	1.67	1.51	0.29	5.33	1.78	1.78	0.31	6.36	2.04	2.04	0.35	8.94	2.30	2.30	0.40	11.53	2.57	2.57	0.44	13.90
		17	2.45	1.51	0.42	12.82	2.43	1.78	0.42	12.65	2.41	2.04	0.41	12.45	2.42	2.31	0.42	12.57	2.57	2.57	0.44	13.95
		19	-	-	-	-	3.29	1.79	0.57	21.21	3.27	2.06	0.56	20.97	3.26	2.32	0.56	20.88	3.23	2.58	0.56	20.71
		20	-	-	-	-	3.75	1.80	0.64	26.46	3.73	2.06	0.64	26.17	3.70	2.33	0.64	25.89	3.68	2.59	0.63	25.61
6	15	1.46	1.39	0.21	2.48	1.65	1.65	0.24	3.22	1.91	1.91	0.27	4.76	2.17	2.17	0.31	6.71	2.43	2.43	0.35	8.88	
	17	2.11	1.37	0.30	6.30	2.09	1.64	0.30	6.14	2.09	1.90	0.30	6.14	2.20	2.17	0.32	6.98	2.43	2.43	0.35	8.91	
	19	-	-	-	-	2.96	1.65	0.43	13.01	2.94	1.91	0.42	12.85	2.92	2.18	0.42	12.69	2.90	2.44	0.42	12.51	
	20	-	-	-	-	3.42	1.65	0.49	16.61	3.40	1.92	0.49	16.42	3.38	2.19	0.48	16.24	3.35	2.45	0.48	16.06	
7	3	15	1.69	1.52	0.49	16.42	1.79	1.79	0.52	18.17	2.05	2.05	0.59	22.65	2.32	2.32	0.67	28.36	2.58	2.58	0.75	33.96
		17	2.49	1.53	0.72	31.87	2.47	1.80	0.71	31.49	2.45	2.06	0.71	31.03	2.44	2.33	0.71	30.86	2.59	2.59	0.75	34.06
		19	-	-	-	-	3.32	1.80	0.96	52.01	3.30	2.07	0.95	51.56	3.28	2.33	0.95	51.20	3.26	2.59	0.94	50.02
		20	-	-	-	-	3.77	1.81	1.09	64.77	3.75	2.07	1.08	63.91	3.72	2.34	1.07	63.39	3.70	2.60	1.07	63.02
	4	15	1.41	1.38	0.30	6.46	1.64	1.64	0.35	9.32	1.92	1.92	0.41	12.37	2.18	2.18	0.47	15.42	2.44	2.44	0.53	18.51
		17	2.16	1.38	0.47	15.09	2.13	1.65	0.46	14.84	2.12	1.92	0.46	14.70	2.21	2.19	0.48	15.73	2.45	2.45	0.53	18.57
		19	-	-	-	-	2.99	1.66	0.64	26.19	2.97	1.93	0.64	25.88	2.95	2.19	0.64	25.58	2.93	2.45	0.63	25.22
		20	-	-	-	-	3.45	1.67	0.75	33.78	3.43	1.94	0.74	33.41	3.41	2.20	0.74	33.04	3.39	2.46	0.73	32.68
	5	15	1.26	1.25	0.22	2.64	1.51	1.51	0.26	4.27	1.77	1.77	0.30	6.56	2.04	2.04	0.35	9.11	2.30	2.30	0.40	11.41
		17	1.79	1.23	0.31	6.76	1.78	1.50	0.31	6.62	1.84	1.78	0.32	7.19	2.04	2.04	0.35	9.15	2.31	2.31	0.40	11.44
		19	-	-	-	-	2.65	1.52	0.46	14.47	2.63	1.78	0.45	14.28	2.64	2.10	0.47	37.50	2.59	2.31	0.45	13.92
		20	-	-	-	-	3.11	1.52	0.53	18.94	3.08	1.79	0.53	18.72	3.06	2.06	0.53	18.50	3.04	2.32	0.52	18.26
6	15	1.12	1.12	0.16	1.73	1.39	1.39	0.20	2.26	1.65	1.65	0.24	3.38	1.90	1.90	0.27	4.95	2.16	2.16	0.31	6.91	
	17	1.48	1.11	0.21	2.58	1.53	1.39	0.22	2.76	1.67	1.65	0.24	3.49	1.91	1.91	0.27	4.97	2.17	2.17	0.31	6.94	
	19	-	-	-	-	2.28	1.37	0.33	7.84	2.26	1.64	0.32	7.67	2.24	1.90	0.32	7.54	2.29	2.17	0.33	7.91	
	20	-	-	-	-	2.75	1.38	0.39	11.21	2.73	1.65	0.39	11.07	2.70	1.91	0.39	10.91	2.68	2.18	0.38	10.74	
9	3	15	1.24	1.24	0.36	9.45	1.52	1.52	0.44	13.29	1.78	1.78	0.51	17.53	2.05	2.05	0.59	22.24	2.32	2.32	0.67	27.76
		17	1.83	1.25	0.53	18.29	1.81	1.52	0.52	17.96	1.84	1.79	0.53	18.48	2.05	2.05	0.59	22.31	2.32	2.32	0.67	27.85
		19	-	-	-	-	2.67	1.53	0.77	35.06	2.65	1.79	0.76	34.64	2.63	2.06	0.76	34.15	2.61	2.32	0.75	33.67
		20	-	-	-	-	3.13	1.53	0.91	46.70	3.11	1.80	0.90	46.17	3.09	2.07	0.90	45.67	3.07	2.33	0.89	45.12
	4	15	1.11	1.11	0.24	3.54	1.37	1.37	0.30	6.18	1.64	1.64	0.35	9.27	1.91	1.91	0.41	12.02	2.18	2.18	0.47	14.99
		17	1.46	1.10	0.31	7.17	1.47	1.37	0.32	7.37	1.65	1.64	0.35	9.30	1.92	1.92	0.41	12.06	2.18	2.18	0.47	15.04
		19	-	-	-	-	2.33	1.39	0.50	16.79	2.30	1.65	0.50	16.52	2.28	1.92	0.49	16.26	2.30	2.19	0.50	16.51
		20	-	-	-	-	2.78	1.39	0.60	22.85	2.76	1.66	0.60	22.59	2.74	1.93	0.59	22.30	2.72	2.19	0.59	21.96
	5	15	0.98	0.98	0.17	1.75	1.25	1.25	0.21	2.66	1.51	1.51	0.26	4.43	1.77	1.77	0.30	6.75	2.04	2.04	0.35	9.09
		17	1.15	0.98	0.20	2.21	1.28	1.25	0.22	2.85	1.51	1.51	0.26	4.46	1.77	1.77	0.31	6.78	2.04	2.04	0.35	9.12
		19	-	-	-	-	1.94	1.24	0.33	8.29	1.92	1.51	0.33	8.11	1.93	1.78	0.33	8.23	2.07	2.05	0.36	9.33
		20	-	-	-	-	2.41	1.25	0.41	12.12	2.39	1.52	0.41	11.95	2.37	1.78	0.41	11.75	2.35	2.05	0.41	11.64
6	15	0.85	0.85	0.12	1.24	1.12	1.12	0.16	1.63	1.39	1.39	0.20	2.24	1.64	1.64	0.24	3.46	1.90	1.90	0.27	5.13	
	17	0.92	0.85	0.13	1.33	1.13	1.13	0.16	1.64	1.39	1.39	0.20	2.24	1.65	1.65	0.24	3.48	1.90	1.90	0.27	5.16	
	19	-	-	-	-	1.58	1.11	0.23	3.14	1.60	1.38	0.23	3.21	1.71	1.65	0.25	3.86	1.91	1.91	0.27	5.18	
	20	-	-	-	-	2.02	1.10	0.29	5.99	1.99	1.37	0.29	5.83	1.98	1.64	0.28	5.74	2.04	1.91	0.29	6.15	

Continued:

MKG-300-BA/ MKG-300A																						
EWT	ΔT	Indoor temp (W.B.)	Indoor temperature (D.B.)																			
			21				23				25				27				29			
			TC	SC	WF	WPD	TC	SC	WF	WPD	TC	SC	WF	WPD	TC	SC	WF	WPD	TC	SC	WF	WPD
°C	°C	°C	kW	kW	m³/h	kPa	kW	kW	m³/h	kPa	kW	kW	m³/h	kPa	kW	kW	m³/h	kPa	kW	kW	m³/h	kPa
11	3	15	0.97	0.97	0.28	5.31	1.24	1.24	0.35	9.22	1.51	1.51	0.43	12.89	1.78	1.78	0.51	17.02	2.05	2.05	0.58	21.59
		17	1.12	0.97	0.32	7.56	1.25	1.25	0.36	9.31	1.52	1.52	0.43	12.93	1.78	1.78	0.51	17.07	2.05	2.05	0.59	21.65
		19	-	-	-	-	1.98	1.25	0.56	20.34	1.96	1.52	0.56	19.95	1.95	1.79	0.56	19.87	2.06	2.06	0.59	21.91
		20	-	-	-	-	2.43	1.26	0.69	29.03	2.41	1.52	0.69	28.66	2.40	1.79	0.69	28.45	2.38	2.06	0.68	28.04
	4	15	0.84	0.84	0.18	1.86	1.11	1.11	0.24	3.56	1.37	1.37	0.29	6.28	1.64	1.64	0.35	9.07	1.91	1.91	0.41	11.71
		17	0.88	0.85	0.19	2.01	1.11	1.11	0.24	3.58	1.37	1.37	0.29	6.31	1.64	1.64	0.35	9.10	1.91	1.91	0.41	11.74
		19	-	-	-	-	1.58	1.11	0.34	8.50	1.58	1.38	0.34	8.46	1.68	1.65	0.36	9.46	1.92	1.92	0.41	11.78
		20	-	-	-	-	2.05	1.11	0.44	13.25	2.03	1.38	0.44	13.01	2.01	1.65	0.43	12.81	2.04	1.92	0.44	13.11
	5	15	0.72	0.72	0.12	1.20	0.98	0.98	0.17	1.68	1.25	1.25	0.21	2.76	1.51	1.51	0.26	4.61	1.77	1.77	0.30	6.88
		17	0.72	0.72	0.12	1.21	0.99	0.99	0.17	1.68	1.25	1.25	0.22	2.77	1.51	1.51	0.26	4.63	1.77	1.77	0.31	6.91
		19	-	-	-	-	1.23	0.97	0.21	2.65	1.32	1.25	0.23	3.23	1.51	1.51	0.26	4.66	1.78	1.78	0.31	6.94
		20	-	-	-	-	1.65	0.97	0.28	5.80	1.63	1.24	0.28	5.66	1.66	1.51	0.29	5.92	1.80	1.78	0.31	7.16
6	15	0.58	0.58	0.08	0.80	0.85	0.85	0.12	1.18	1.12	1.12	0.16	1.55	1.38	1.38	0.20	2.27	1.64	1.64	0.24	3.59	
	17	0.58	0.58	0.08	0.80	0.86	0.86	0.12	1.18	1.12	1.12	0.16	1.56	1.39	1.39	0.20	2.28	1.64	1.64	0.24	3.61	
	19	-	-	-	-	0.96	0.85	0.14	1.32	1.15	1.13	0.16	1.59	1.39	1.39	0.20	2.30	1.65	1.65	0.24	3.63	
	20	-	-	-	-	1.28	0.84	0.18	1.91	1.32	1.12	0.19	2.02	1.45	1.39	0.21	2.58	1.65	1.65	0.24	3.64	
13	3	15	0.70	0.70	0.20	2.36	0.97	0.97	0.28	5.59	1.24	1.24	0.36	9.19	1.51	1.51	0.43	12.64	1.78	1.78	0.51	16.94
		17	0.70	0.70	0.20	2.37	0.97	0.97	0.28	5.61	1.24	1.24	0.36	9.22	1.51	1.51	0.43	12.68	1.78	1.78	0.51	16.99
		19	-	-	-	-	1.22	0.97	0.35	8.87	1.29	1.25	0.37	9.76	1.51	1.51	0.43	12.72	1.79	1.79	0.51	17.05
		20	-	-	-	-	1.68	0.98	0.48	15.39	1.66	1.25	0.48	15.06	1.67	1.52	0.48	15.14	1.80	1.79	0.52	17.25
	4	15	0.57	0.57	0.12	1.16	0.84	0.84	0.18	1.85	1.11	1.11	0.24	3.74	1.37	1.37	0.29	6.37	1.64	1.64	0.35	8.91
		17	0.57	0.57	0.12	1.17	0.85	0.85	0.18	1.86	1.11	1.11	0.24	3.76	1.37	1.37	0.29	6.40	1.64	1.64	0.35	8.93
		19	-	-	-	-	0.91	0.85	0.20	2.24	1.11	1.11	0.24	3.78	1.37	1.37	0.29	6.43	1.65	1.65	0.35	8.96
		20	-	-	-	-	1.24	0.83	0.27	5.07	1.26	1.10	0.27	5.20	1.40	1.38	0.30	6.68	1.65	1.65	0.35	8.98
	5	15	0.44	0.44	0.08	0.70	0.71	0.71	0.12	1.13	0.98	0.98	0.17	1.61	1.24	1.24	0.21	2.80	1.50	1.50	0.26	4.69
		17	0.44	0.44	0.08	0.70	0.71	0.71	0.12	1.13	0.98	0.98	0.17	1.62	1.24	1.24	0.21	2.82	1.51	1.51	0.26	4.71
		19	-	-	-	-	0.73	0.72	0.12	1.16	0.99	0.99	0.17	1.62	1.25	1.25	0.21	2.83	1.51	1.51	0.26	4.73
		20	-	-	-	-	0.90	0.71	0.15	1.42	1.04	0.99	0.18	1.80	1.25	1.25	0.21	2.84	1.51	1.51	0.26	4.75
6	15	0.30	0.30	0.04	0.39	0.58	0.58	0.08	0.76	0.85	0.85	0.12	1.11	1.12	1.12	0.16	1.49	1.38	1.38	0.20	2.31	
	17	0.30	0.30	0.04	0.39	0.58	0.58	0.08	0.76	0.85	0.85	0.12	1.11	1.12	1.12	0.16	1.49	1.38	1.38	0.20	2.32	
	19	-	-	-	-	0.58	0.58	0.08	0.76	0.86	0.86	0.12	1.11	1.12	1.12	0.16	1.49	1.39	1.39	0.20	2.33	
	20	-	-	-	-	0.65	0.58	0.09	0.84	0.87	0.86	0.12	1.13	1.13	1.13	0.16	1.50	1.39	1.39	0.20	2.34	
15	3	15	0.43	0.43	0.12	1.12	0.70	0.70	0.20	2.37	0.97	0.97	0.28	5.58	1.24	1.24	0.35	8.91	1.51	1.51	0.43	12.44
		17	0.43	0.43	0.12	1.12	0.70	0.70	0.20	2.38	0.97	0.97	0.28	5.61	1.24	1.24	0.35	8.94	1.51	1.51	0.43	12.48
		19	-	-	-	-	0.70	0.70	0.20	2.39	0.97	0.97	0.28	5.63	1.24	1.24	0.35	8.97	1.51	1.51	0.43	12.52
		20	-	-	-	-	0.85	0.69	0.24	4.10	0.98	0.98	0.28	5.82	1.25	1.24	0.36	8.98	1.52	1.52	0.43	12.54
	4	15	0.30	0.30	0.06	0.57	0.57	0.57	0.12	1.10	0.84	0.84	0.18	1.84	1.10	1.10	0.24	3.81	1.37	1.37	0.29	6.42
		17	0.30	0.30	0.06	0.57	0.57	0.57	0.12	1.10	0.84	0.84	0.18	1.85	1.10	1.10	0.24	3.82	1.37	1.37	0.29	6.44
		19	-	-	-	-	0.57	0.57	0.12	1.10	0.84	0.84	0.18	1.86	1.11	1.11	0.24	3.84	1.38	1.38	0.29	6.47
		20	-	-	-	-	0.61	0.58	0.13	1.17	0.84	0.84	0.18	1.86	1.11	1.11	0.24	3.85	1.38	1.38	0.30	6.48
	5	15	0.16	0.16	0.03	0.24	0.44	0.44	0.08	0.67	0.71	0.71	0.12	1.08	0.98	0.98	0.17	1.61	1.24	1.24	0.21	2.94
		17	0.16	0.16	0.03	0.24	0.44	0.44	0.08	0.67	0.72	0.72	0.12	1.09	0.98	0.98	0.17	1.62	1.24	1.24	0.21	2.95
		19	-	-	-	-	0.44	0.44	0.08	0.67	0.72	0.72	0.12	1.09	0.99	0.99	0.17	1.62	1.25	1.25	0.21	2.97
		20	-	-	-	-	0.44	0.44	0.08	0.67	0.72	0.72	0.12	1.09	0.99	0.99	0.17	1.63	1.25	1.25	0.21	2.98
6	15	-	-	-	-	0.30	0.30	0.04	0.37	0.58	0.58	0.08	0.72	0.85	0.85	0.12	1.06	1.12	1.12	0.16	1.46	
	17	-	-	-	-	0.30	0.30	0.04	0.38	0.58	0.58	0.08	0.72	0.85	0.85	0.12	1.06	1.12	1.12	0.16	1.47	
	19	-	-	-	-	0.31	0.31	0.04	0.38	0.58	0.58	0.08	0.72	0.86	0.86	0.12	1.06	1.12	1.12	0.16	1.47	
	20	-	-	-	-	0.31	0.31	0.04	0.38	0.58	0.58	0.08	0.73	0.86	0.86	0.12	1.07	1.12	1.12	0.16	1.47	

Cooling Capacity

MKG-400-BA/ MKG-400A																						
EWT	ΔT	Indoor temp (W.B.)	Indoor temperature (D.B.)																			
			21				23				25				27				29			
			TC	SC	WF	WPD	TC	SC	WF	WPD	TC	SC	WF	WPD	TC	SC	WF	WPD	TC	SC	WF	WPD
°C	°C	°C	kW	kW	m³/h	kPa	kW	kW	m³/h	kPa	kW	kW	m³/h	kPa	kW	kW	m³/h	kPa	kW	kW	m³/h	kPa
5	3	15	2.53	1.98	0.72	32.71	2.51	2.27	0.72	32.25	2.58	2.57	0.74	33.94	2.87	2.87	0.82	40.82	3.16	3.16	0.91	48.59
		17	3.41	1.98	0.98	54.67	3.39	2.28	0.97	54.15	3.37	2.58	0.96	53.64	3.35	2.87	0.96	53.07	3.33	3.16	0.95	52.52
		19	-	-	-	-	4.33	2.29	1.24	83.04	4.30	2.58	1.24	82.29	4.28	2.88	1.23	81.54	4.26	3.17	1.22	80.81
		20	-	-	-	-	4.83	2.29	1.39	101.35	4.81	2.59	1.39	100.80	4.78	2.88	1.37	98.81	4.75	3.17	1.37	97.92
	4	15	2.17	1.81	0.46	15.29	2.19	2.11	0.47	15.60	2.42	2.41	0.52	18.57	2.71	2.71	0.58	22.40	3.00	3.00	0.64	26.63
		17	3.06	1.82	0.66	27.49	3.04	2.12	0.65	27.22	3.02	2.42	0.65	26.94	3.00	2.71	0.64	26.60	3.06	3.01	0.66	27.48
		19	-	-	-	-	3.99	2.13	0.86	43.44	3.97	2.43	0.85	43.02	3.94	2.72	0.85	42.63	3.92	3.01	0.84	42.25
		20	-	-	-	-	4.49	2.14	0.97	53.62	4.47	2.43	0.96	53.13	4.44	2.73	0.96	52.56	4.42	3.02	0.95	51.97
	5	15	1.81	1.65	0.31	6.60	1.96	1.95	0.34	8.11	2.25	2.25	0.39	11.03	2.55	2.55	0.44	13.74	2.85	2.85	0.49	16.70
		17	2.70	1.66	0.46	15.24	2.68	1.96	0.46	15.08	2.66	2.26	0.46	14.86	2.68	2.56	0.46	15.09	2.85	2.85	0.49	16.77
		19	-	-	-	-	3.63	1.97	0.62	25.06	3.61	2.27	0.62	24.82	3.59	2.56	0.62	24.57	3.57	2.86	0.61	24.33
		20	-	-	-	-	4.14	1.98	0.71	31.63	4.12	2.28	0.71	31.33	4.10	2.57	0.71	31.05	4.07	2.87	0.70	30.76
6	15	1.60	1.52	0.23	2.97	1.81	1.81	0.26	4.12	2.10	2.10	0.30	6.14	2.39	2.39	0.34	8.55	2.69	2.69	0.38	10.93	
	17	2.30	1.49	0.33	7.81	2.28	1.79	0.33	7.64	2.29	2.09	0.33	7.69	2.42	2.39	0.35	8.83	2.69	2.69	0.39	10.96	
	19	-	-	-	-	3.26	1.81	0.47	15.30	3.24	2.11	0.46	15.15	3.22	2.41	0.46	14.99	3.19	2.70	0.46	14.79	
	20	-	-	-	-	3.76	1.82	0.54	19.41	3.74	2.12	0.53	19.22	3.72	2.41	0.53	19.03	3.70	2.70	0.53	18.84	
7	3	15	1.86	1.68	0.54	19.35	1.98	1.98	0.57	21.25	2.27	2.27	0.65	26.95	2.57	2.57	0.74	33.72	2.86	2.86	0.83	40.61
		17	2.74	1.68	0.79	37.72	2.73	1.98	0.79	37.31	2.71	2.28	0.78	36.84	2.70	2.57	0.78	36.69	2.87	2.87	0.83	40.70
		19	-	-	-	-	3.67	1.99	1.05	61.60	3.64	2.28	1.05	60.91	3.62	2.58	1.04	60.32	3.60	2.87	1.04	59.73
		20	-	-	-	-	4.16	1.99	1.20	76.90	4.14	2.29	1.19	76.18	4.12	2.58	1.19	75.46	4.10	2.88	1.18	74.76
	4	15	1.55	1.51	0.33	8.16	1.82	1.82	0.39	11.25	2.12	2.12	0.46	14.68	2.41	2.41	0.52	18.15	2.71	2.71	0.58	22.09
		17	2.36	1.52	0.51	17.52	2.34	1.82	0.50	17.27	2.33	2.12	0.50	17.12	2.44	2.42	0.53	18.53	2.71	2.71	0.58	22.15
		19	-	-	-	-	3.31	1.83	0.72	31.44	3.29	2.13	0.71	31.12	3.27	2.43	0.71	30.80	3.25	2.72	0.70	30.43
		20	-	-	-	-	3.81	1.84	0.82	40.07	3.78	2.13	0.81	39.17	3.76	2.43	0.81	38.79	3.74	2.72	0.80	38.42
	5	15	1.38	1.38	0.24	3.32	1.66	1.66	0.29	5.50	1.95	1.95	0.34	8.31	2.25	2.25	0.39	11.01	2.55	2.55	0.44	13.59
		17	1.96	1.35	0.34	8.35	1.94	1.65	0.33	8.19	2.02	1.96	0.35	8.98	2.26	2.26	0.39	11.04	2.56	2.56	0.44	13.62
		19	-	-	-	-	2.92	1.67	0.50	17.13	2.90	1.97	0.50	16.95	2.94	2.35	0.53	17.16	2.86	2.56	0.49	16.57
		20	-	-	-	-	3.42	1.68	0.59	22.40	3.40	1.98	0.59	22.17	3.38	2.27	0.58	21.95	3.36	2.57	0.58	21.72
6	15	1.24	1.24	0.18	1.92	1.53	1.53	0.22	2.77	1.81	1.81	0.26	4.36	2.10	2.10	0.30	6.38	2.39	2.39	0.34	8.71	
	17	1.61	1.21	0.23	3.15	1.66	1.52	0.24	3.45	1.83	1.82	0.26	4.48	2.10	2.10	0.30	6.41	2.40	2.40	0.34	8.73	
	19	-	-	-	-	2.50	1.50	0.36	9.51	2.48	1.80	0.36	9.36	2.46	2.10	0.35	9.23	2.53	2.40	0.36	9.71	
	20	-	-	-	-	3.03	1.52	0.44	13.34	3.01	1.82	0.43	13.20	2.98	2.11	0.43	12.90	2.96	2.41	0.42	12.72	
9	3	15	1.37	1.37	0.39	11.22	1.68	1.68	0.48	15.88	1.98	1.98	0.57	20.87	2.28	2.28	0.66	26.93	2.57	2.57	0.74	32.70
		17	2.02	1.38	0.58	21.67	2.00	1.68	0.57	21.27	2.04	1.98	0.59	22.02	2.28	2.28	0.66	26.99	2.57	2.57	0.74	32.79
		19	-	-	-	-	2.96	1.69	0.86	42.40	2.93	1.98	0.84	41.22	2.91	2.28	0.84	40.76	2.89	2.57	0.83	40.18
		20	-	-	-	-	3.45	1.69	0.99	54.66	3.43	1.99	0.99	54.11	3.41	2.28	0.98	53.55	3.39	2.58	0.98	53.00
	4	15	1.22	1.22	0.26	4.46	1.51	1.51	0.33	7.83	1.82	1.82	0.39	11.05	2.12	2.12	0.46	14.31	2.42	2.42	0.52	17.97
		17	1.60	1.21	0.34	8.79	1.62	1.52	0.35	9.07	1.82	1.82	0.39	11.10	2.12	2.12	0.46	14.35	2.42	2.42	0.52	18.02
		19	-	-	-	-	2.57	1.53	0.55	19.92	2.55	1.83	0.55	19.68	2.52	2.12	0.54	19.38	2.55	2.42	0.55	19.76
		20	-	-	-	-	3.07	1.53	0.67	27.26	3.05	1.83	0.66	26.97	3.03	2.13	0.66	26.69	3.01	2.43	0.65	26.33
	5	15	1.08	1.08	0.19	1.99	1.37	1.37	0.24	3.42	1.66	1.66	0.29	5.73	1.96	1.96	0.34	8.44	2.26	2.26	0.39	10.88
		17	1.25	1.07	0.22	2.68	1.40	1.37	0.24	3.63	1.66	1.66	0.29	5.75	1.96	1.96	0.34	8.46	2.26	2.26	0.39	10.91
		19	-	-	-	-	2.14	1.36	0.37	9.89	2.11	1.66	0.36	9.71	2.14	1.96	0.37	9.91	2.30	2.27	0.40	11.18
		20	-	-	-	-	2.66	1.38	0.46	14.42	2.64	1.68	0.46	14.27	2.62	1.97	0.45	14.08	2.61	2.27	0.45	13.96
6	15	0.94	0.94	0.14	1.37	1.24	1.24	0.18	1.84	1.53	1.53	0.22	2.83	1.81	1.81	0.26	4.49	2.10	2.10	0.30	6.60	
	17	1.01	0.94	0.15	1.47	1.24	1.24	0.18	1.85	1.53	1.53	0.22	2.84	1.81	1.81	0.26	4.51	2.10	2.10	0.30	6.62	
	19	-	-	-	-	1.72	1.21	0.25	3.89	1.74	1.51	0.25	4.01	1.87	1.81	0.27	4.93	2.11	2.11	0.30	6.65	
	20	-	-	-	-	2.21	1.21	0.32	7.40	2.18	1.51	0.31	7.23	2.17	1.80	0.31	7.13	2.25	2.11	0.32	7.70	

Continued:

MKG-400-BA/ MKG-400A																							
EWT	ΔT	Indoor temp (W.B.)	Indoor temperature (D.B.)																				
			21				23				25				27				29				
			TC	SC	WF	WPD	TC	SC	WF	WPD	TC	SC	WF	WPD	TC	SC	WF	WPD	TC	SC	WF	WPD	
°C	°C	°C	kW	kW	m³/h	kPa	kW	kW	m³/h	kPa	kW	kW	m³/h	kPa	kW	kW	m³/h	kPa	kW	kW	m³/h	kPa	
11	3	15	1.07	1.07	0.30	6.76	1.37	1.37	0.39	10.94	1.68	1.68	0.48	15.36	1.97	1.97	0.56	20.31	2.27	2.27	0.65	25.82	
		17	1.23	1.07	0.35	9.08	1.38	1.38	0.39	11.07	1.68	1.68	0.48	15.38	1.98	1.98	0.56	20.37	2.27	2.27	0.65	25.89	
		19	-	-	-	-	2.19	1.38	0.62	24.16	2.16	1.68	0.62	23.75	2.16	1.98	0.62	23.64	2.29	2.28	0.65	26.22	
		20	-	-	-	-	2.69	1.39	0.77	34.79	2.67	1.69	0.77	34.39	2.65	1.98	0.76	33.95	2.63	2.28	0.75	33.13	
	4	15	0.93	0.93	0.20	2.24	1.22	1.22	0.26	4.60	1.52	1.52	0.32	7.85	1.82	1.82	0.39	10.80	2.12	2.12	0.45	13.98	
		17	0.97	0.93	0.21	2.48	1.22	1.22	0.26	4.62	1.52	1.52	0.33	7.87	1.82	1.82	0.39	10.83	2.12	2.12	0.45	14.01	
		19	-	-	-	-	1.75	1.22	0.37	10.06	1.74	1.52	0.37	10.02	1.87	1.83	0.40	11.29	2.12	2.12	0.46	14.05	
		20	-	-	-	-	2.27	1.23	0.49	15.67	2.25	1.53	0.48	15.44	2.23	1.83	0.48	15.19	2.26	2.13	0.49	15.65	
	5	15	0.79	0.79	0.14	1.33	1.09	1.09	0.19	1.97	1.37	1.37	0.24	3.57	1.66	1.66	0.29	5.94	1.96	1.96	0.34	8.44	
		17	0.80	0.79	0.14	1.34	1.09	1.09	0.19	1.98	1.38	1.38	0.24	3.59	1.67	1.67	0.29	5.96	1.97	1.97	0.34	8.46	
		19	-	-	-	-	1.33	1.07	0.23	3.29	1.44	1.37	0.25	4.11	1.67	1.67	0.29	5.99	1.97	1.97	0.34	8.49	
		20	-	-	-	-	1.81	1.06	0.31	7.19	1.79	1.36	0.31	7.01	1.83	1.67	0.32	7.39	2.00	1.97	0.35	8.73	
	6	15	0.65	0.65	0.09	0.89	0.95	0.95	0.14	1.31	1.24	1.24	0.18	1.80	1.53	1.53	0.22	2.94	1.81	1.81	0.26	4.68	
		17	0.65	0.65	0.09	0.89	0.95	0.95	0.14	1.31	1.24	1.24	0.18	1.80	1.53	1.53	0.22	2.95	1.81	1.81	0.26	4.69	
		19	-	-	-	-	1.06	0.94	0.15	1.46	1.27	1.24	0.18	1.86	1.53	1.53	0.22	2.96	1.82	1.82	0.26	4.72	
		20	-	-	-	-	1.40	0.92	0.20	2.32	1.44	1.23	0.21	2.51	1.59	1.53	0.23	3.29	1.82	1.82	0.26	4.73	
	13	3	15	0.77	0.77	0.22	3.05	1.07	1.07	0.31	7.03	1.38	1.38	0.40	10.94	1.68	1.68	0.48	15.33	1.98	1.98	0.57	20.27
			17	0.77	0.77	0.22	3.06	1.07	1.07	0.31	7.06	1.38	1.38	0.40	10.97	1.68	1.68	0.48	15.37	1.98	1.98	0.57	20.32
			19	-	-	-	-	1.34	1.07	0.39	10.47	1.43	1.38	0.41	11.66	1.68	1.68	0.48	15.41	1.98	1.98	0.57	20.38
			20	-	-	-	-	1.86	1.08	0.53	18.30	1.84	1.38	0.53	17.90	1.84	1.68	0.53	18.02	2.00	1.99	0.57	20.65
4		15	0.63	0.63	0.14	1.29	0.93	0.93	0.20	2.33	1.22	1.22	0.26	4.86	1.52	1.52	0.33	7.82	1.82	1.82	0.39	10.64	
		17	0.64	0.64	0.14	1.29	0.93	0.93	0.20	2.34	1.22	1.22	0.26	4.88	1.52	1.52	0.33	7.84	1.82	1.82	0.39	10.66	
		19	-	-	-	-	1.00	0.93	0.22	2.85	1.22	1.22	0.26	4.89	1.52	1.52	0.33	7.86	1.83	1.83	0.39	10.69	
		20	-	-	-	-	1.36	0.91	0.29	6.32	1.38	1.22	0.30	6.50	1.55	1.53	0.33	8.14	1.83	1.83	0.39	10.71	
5		15	0.49	0.49	0.08	0.78	0.79	0.79	0.14	1.26	1.08	1.08	0.19	1.96	1.37	1.37	0.24	3.65	1.66	1.66	0.29	6.01	
		17	0.49	0.49	0.08	0.78	0.79	0.79	0.14	1.26	1.09	1.09	0.19	1.97	1.37	1.37	0.24	3.67	1.67	1.67	0.29	6.03	
		19	-	-	-	-	0.81	0.79	0.14	1.28	1.09	1.09	0.19	1.97	1.37	1.37	0.24	3.69	1.67	1.67	0.29	6.05	
		20	-	-	-	-	0.98	0.78	0.17	1.61	1.14	1.08	0.20	2.24	1.38	1.37	0.24	3.69	1.67	1.67	0.29	6.06	
6		15	0.34	0.34	0.05	0.44	0.65	0.65	0.09	0.84	0.95	0.95	0.14	1.24	1.24	1.24	0.18	1.78	1.52	1.52	0.22	3.01	
		17	0.34	0.34	0.05	0.44	0.65	0.65	0.09	0.84	0.95	0.95	0.14	1.24	1.24	1.24	0.18	1.78	1.53	1.53	0.22	3.03	
		19	-	-	-	-	0.65	0.65	0.09	0.85	0.95	0.95	0.14	1.24	1.24	1.24	0.18	1.79	1.53	1.53	0.22	3.04	
		20	-	-	-	-	0.71	0.64	0.10	0.93	0.96	0.95	0.14	1.26	1.25	1.24	0.18	1.79	1.53	1.53	0.22	3.05	
15		3	15	0.48	0.48	0.14	1.24	0.77	0.77	0.22	3.08	1.07	1.07	0.31	6.93	1.37	1.37	0.39	10.63	1.68	1.68	0.48	15.10
			17	0.48	0.48	0.14	1.24	0.77	0.77	0.22	3.09	1.07	1.07	0.31	6.95	1.38	1.38	0.39	10.66	1.68	1.68	0.48	15.14
			19	-	-	-	-	0.77	0.77	0.22	3.09	1.07	1.07	0.31	6.97	1.38	1.38	0.39	10.69	1.68	1.68	0.48	15.18
			20	-	-	-	-	0.93	0.76	0.27	5.12	1.09	1.08	0.31	7.18	1.38	1.38	0.39	10.70	1.68	1.68	0.48	15.21
	4	15	0.33	0.33	0.07	0.64	0.63	0.63	0.14	1.22	0.93	0.93	0.20	2.37	1.22	1.22	0.26	4.93	1.52	1.52	0.33	7.74	
		17	0.33	0.33	0.07	0.64	0.64	0.64	0.14	1.22	0.93	0.93	0.20	2.38	1.22	1.22	0.26	4.95	1.52	1.52	0.33	7.76	
		19	-	-	-	-	0.64	0.64	0.14	1.22	0.93	0.93	0.20	2.39	1.22	1.22	0.26	4.97	1.53	1.53	0.33	7.78	
		20	-	-	-	-	0.67	0.64	0.14	1.29	0.93	0.93	0.20	2.39	1.22	1.22	0.26	4.98	1.53	1.53	0.33	7.79	
	5	15	0.18	0.18	0.03	0.27	0.49	0.49	0.08	0.75	0.79	0.79	0.14	1.21	1.09	1.09	0.19	2.04	1.37	1.37	0.24	3.85	
		17	0.18	0.18	0.03	0.27	0.49	0.49	0.08	0.75	0.79	0.79	0.14	1.21	1.09	1.09	0.19	2.05	1.37	1.37	0.24	3.87	
		19	-	-	-	-	0.49	0.49	0.09	0.75	0.80	0.80	0.14	1.21	1.09	1.09	0.19	2.06	1.38	1.38	0.24	3.88	
		20	-	-	-	-	0.50	0.49	0.09	0.75	0.80	0.80	0.14	1.21	1.09	1.09	0.19	2.06	1.38	1.38	0.24	3.89	
	6	15	-	-	-	-	0.34	0.34	0.05	0.42	0.65	0.65	0.09	0.81	0.95	0.95	0.14	1.18	1.24	1.24	0.18	1.82	
		17	-	-	-	-	0.34	0.34	0.05	0.42	0.65	0.65	0.09	0.81	0.95	0.95	0.14	1.19	1.24	1.24	0.18	1.83	
		19	-	-	-	-	0.34	0.34	0.05	0.43	0.65	0.65	0.09	0.81	0.95	0.95	0.14	1.19	1.24	1.24	0.18	1.83	
		20	-	-	-	-	0.34	0.34	0.05	0.43	0.65	0.65	0.09	0.81	0.95	0.95	0.14	1.19	1.25	1.25	0.18	1.84	

Cooling Capacity

MKG-500-BA/MKG-500A																							
EWT	ΔT	Indoor temp (W.B.)	Indoor temperature (D.B.)																				
			21				23				25				27				29				
			TC	SC	WF	WPD	TC	SC	WF	WPD	TC	SC	WF	WPD	TC	SC	WF	WPD	TC	SC	WF	WPD	
°C	°C	°C	kW	kW	m³/h	kPa	kW	kW	m³/h	kPa	kW	kW	m³/h	kPa	kW	kW	m³/h	kPa	kW	kW	m³/h	kPa	
5	3	15	3.39	2.62	0.98	76.29	3.36	3.00	0.97	75.22	3.44	3.39	0.99	77.73	3.77	3.77	1.09	91.90	4.14	4.14	1.20	108.63	
		17	4.53	2.62	1.31	126.85	4.50	3.01	1.31	125.52	4.48	3.39	1.30	124.35	4.45	3.78	1.28	121.79	4.42	4.15	1.28	120.88	
		19	-	-	-	-	5.71	3.02	1.65	188.37	5.68	3.40	1.64	186.67	5.65	3.78	1.63	184.96	5.62	4.16	1.62	183.21	
		20	-	-	-	-	6.36	3.02	1.83	227.08	6.33	3.40	1.83	225.02	6.30	3.78	1.82	223.02	6.27	4.17	1.81	221.26	
	4	15	2.95	2.42	0.63	35.89	2.98	2.81	0.64	36.52	3.20	3.20	0.69	41.31	3.58	3.58	0.77	50.05	3.96	3.96	0.85	59.84	
		17	4.11	2.43	0.89	64.15	4.09	2.82	0.88	63.52	4.06	3.20	0.88	62.84	4.03	3.58	0.87	62.09	4.09	3.96	0.88	63.73	
		19	-	-	-	-	5.31	2.83	1.15	100.34	5.28	3.21	1.14	99.39	5.26	3.60	1.14	98.45	5.22	3.97	1.12	96.28	
		20	-	-	-	-	5.96	2.83	1.29	122.86	5.92	3.22	1.28	120.23	5.89	3.60	1.27	119.14	5.85	3.97	1.26	118.01	
	5	15	2.52	2.22	0.43	18.87	2.68	2.62	0.46	20.88	3.00	3.00	0.52	25.17	3.39	3.39	0.58	31.21	3.77	3.77	0.65	37.44	
		17	3.67	2.24	0.63	35.74	3.65	2.62	0.63	35.36	3.62	3.01	0.62	34.87	3.65	3.39	0.63	35.36	3.83	3.78	0.66	38.34	
		19	-	-	-	-	4.88	2.64	0.84	58.13	4.85	3.02	0.84	57.54	4.83	3.40	0.83	56.97	4.80	3.78	0.83	56.37	
		20	-	-	-	-	5.54	2.64	0.96	72.59	5.51	3.03	0.95	71.89	5.48	3.41	0.95	71.22	5.45	3.79	0.94	70.53	
	6	15	2.17	2.02	0.31	9.36	2.43	2.42	0.35	12.40	2.81	2.81	0.40	16.52	3.20	3.20	0.46	20.43	3.58	3.58	0.51	24.77	
		17	3.20	2.03	0.46	20.45	3.17	2.42	0.45	20.13	3.18	2.81	0.46	20.25	3.33	3.20	0.48	21.85	3.59	3.59	0.51	24.90	
		19	-	-	-	-	4.43	2.44	0.63	35.58	4.41	2.83	0.63	35.54	4.38	3.21	0.63	35.18	4.35	3.59	0.62	34.73	
		20	-	-	-	-	5.09	2.45	0.73	45.55	5.06	2.84	0.73	45.09	5.04	3.22	0.72	44.64	5.01	3.60	0.72	44.18	
	7	3	15	2.51	2.22	0.72	44.24	2.64	2.61	0.76	48.43	2.99	2.99	0.86	60.23	3.38	3.38	0.97	74.23	3.76	3.76	1.08	89.40
			17	3.66	2.23	1.06	86.51	3.64	2.62	1.06	85.59	3.61	3.00	1.05	84.49	3.60	3.38	1.05	84.19	3.77	3.77	1.09	90.03
			19	-	-	-	-	4.86	2.62	1.41	140.98	4.83	3.01	1.41	140.98	4.80	3.39	1.39	137.61	4.77	3.77	1.38	136.27
			20	-	-	-	-	5.51	2.63	1.61	177.63	5.48	3.02	1.60	175.94	5.45	3.40	1.59	174.31	5.42	3.78	1.58	172.56
4		15	2.14	2.02	0.46	20.53	2.42	2.42	0.52	25.30	2.81	2.81	0.61	32.99	3.19	3.19	0.69	41.10	3.58	3.58	0.77	49.88	
		17	3.21	2.04	0.70	41.49	3.19	2.42	0.69	40.94	3.17	2.81	0.69	40.59	3.29	3.20	0.71	43.22	3.58	3.58	0.78	50.01	
		19	-	-	-	-	4.42	2.44	0.96	71.83	4.39	2.82	0.95	71.06	4.37	3.20	0.95	70.29	4.34	3.58	0.94	69.44	
		20	-	-	-	-	5.08	2.44	1.10	91.69	5.05	2.83	1.10	90.79	5.02	3.21	1.09	89.86	4.99	3.59	1.08	88.93	
5		15	1.86	1.83	0.32	10.22	2.22	2.22	0.38	14.93	2.62	2.62	0.45	19.65	3.00	3.00	0.52	24.86	3.39	3.39	0.59	30.79	
		17	2.73	1.83	0.47	21.04	2.70	2.22	0.47	20.77	2.80	2.62	0.48	22.03	3.03	3.01	0.52	25.23	3.39	3.39	0.59	30.87	
		19	-	-	-	-	3.96	2.24	0.68	39.79	3.93	2.63	0.68	39.35	4.01	3.30	0.72	47.13	3.88	3.39	0.67	38.53	
		20	-	-	-	-	4.61	2.25	0.79	51.77	4.58	2.63	0.79	51.26	4.56	3.02	0.79	51.13	4.53	3.40	0.78	50.73	
6		15	1.66	1.65	0.24	4.70	2.03	2.03	0.29	8.15	2.42	2.42	0.35	12.37	2.81	2.81	0.40	16.23	3.20	3.20	0.46	20.25	
		17	2.20	1.62	0.32	10.05	2.28	2.02	0.33	10.84	2.49	2.42	0.36	13.08	2.82	2.81	0.40	16.27	3.20	3.20	0.46	20.30	
		19	-	-	-	-	3.48	2.05	0.50	23.37	3.45	2.43	0.50	23.03	3.42	2.82	0.49	22.68	3.50	3.21	0.50	23.67	
		20	-	-	-	-	4.13	2.05	0.59	31.15	4.10	2.44	0.59	30.81	4.07	2.82	0.58	30.45	4.04	3.20	0.58	30.03	
9		3	15	1.83	1.83	0.53	25.46	2.22	2.22	0.64	35.35	2.61	2.61	0.76	47.37	2.99	2.99	0.86	59.22	3.37	3.37	0.98	74.03
			17	2.73	1.83	0.79	51.10	2.70	2.22	0.78	50.23	2.74	2.61	0.79	51.12	2.99	2.99	0.86	59.37	3.38	3.38	0.98	74.24
			19	-	-	-	-	3.93	2.23	1.13	95.42	3.91	2.62	1.13	94.44	3.88	3.00	1.13	94.31	3.86	3.38	1.12	93.55
			20	-	-	-	-	4.59	2.24	1.34	127.12	4.56	2.62	1.33	125.75	4.54	3.01	1.32	124.50	4.51	3.39	1.31	123.16
	4	15	1.63	1.63	0.35	12.67	2.03	2.03	0.44	18.55	2.42	2.42	0.52	25.18	2.80	2.80	0.60	32.08	3.19	3.19	0.69	39.97	
		17	2.23	1.63	0.48	21.69	2.26	2.03	0.49	22.22	2.46	2.43	0.53	25.93	2.81	2.81	0.61	32.16	3.20	3.20	0.69	40.54	
		19	-	-	-	-	3.47	2.04	0.75	46.60	3.44	2.43	0.75	46.00	3.41	2.81	0.74	45.32	3.45	3.20	0.75	46.14	
		20	-	-	-	-	4.11	2.04	0.89	61.97	4.08	2.43	0.88	61.30	4.06	2.81	0.88	60.60	4.02	3.20	0.87	59.76	
	5	15	1.44	1.44	0.25	5.46	1.83	1.83	0.32	10.12	2.23	2.23	0.38	14.80	2.62	2.62	0.45	19.37	3.00	3.00	0.52	24.48	
		17	1.72	1.43	0.30	8.72	1.92	1.83	0.33	11.19	2.23	2.23	0.39	14.85	2.62	2.62	0.45	19.42	3.01	3.01	0.52	24.54	
		19	-	-	-	-	2.95	1.84	0.51	23.79	2.93	2.23	0.50	23.39	2.96	2.62	0.51	23.85	3.12	3.01	0.54	26.19	
		20	-	-	-	-	3.62	1.85	0.63	33.83	3.59	2.24	0.62	33.22	3.56	2.62	0.61	32.72	3.54	3.01	0.61	32.49	
	6	15	1.27	1.27	0.18	2.64	1.65	1.65	0.24	4.86	2.03	2.03	0.29	8.45	2.42	2.42	0.35	12.36	2.81	2.81	0.40	15.97	
		17	1.41	1.26	0.20	3.24	1.68	1.65	0.24	5.09	2.04	2.04	0.29	8.48	2.43	2.43	0.35	12.40	2.82	2.82	0.40	16.02	
		19	-	-	-	-	2.40	1.63	0.34	12.11	2.42	2.03	0.35	12.36	2.60	2.43	0.37	13.94	2.86	2.82	0.41	16.39	
		20	-	-	-	-	3.09	1.65	0.44	18.69	3.06	2.04	0.44	18.36	3.04	2.42	0.44	18.21	3.13	2.82	0.45	19.19	

Continued:

MKG-500-BA/MKG-500A																						
EWT	ΔT	Indoor temp (W.B.)	Indoor temperature (D.B.)																			
			21				23				25				27				29			
			TC	SC	WF	WPD	TC	SC	WF	WPD	TC	SC	WF	WPD	TC	SC	WF	WPD	TC	SC	WF	WPD
°C	°C	°C	kW	kW	m ³ /h	kPa	kW	kW	m ³ /h	kPa	kW	kW	m ³ /h	kPa	kW	kW	m ³ /h	kPa	kW	kW	m ³ /h	kPa
11	3	15	1.43	1.43	0.41	16.26	1.83	1.83	0.52	24.67	2.22	2.22	0.64	34.63	2.60	2.60	0.74	45.34	2.98	2.98	0.85	57.52
		17	1.71	1.43	0.49	22.04	1.87	1.83	0.54	25.79	2.22	2.22	0.64	34.72	2.61	2.61	0.74	45.46	2.99	2.99	0.86	57.67
		19	-	-	-	-	2.93	1.83	0.84	55.74	2.91	2.22	0.83	55.01	2.90	2.61	0.83	55.02	3.05	3.00	0.87	59.66
		20	-	-	-	-	3.59	1.84	1.03	79.18	3.56	2.23	1.02	78.28	3.54	2.61	1.01	77.25	3.50	2.99	1.00	76.08
	4	15	1.24	1.24	0.26	6.66	1.63	1.63	0.35	12.46	2.03	2.03	0.43	17.99	2.42	2.42	0.52	24.28	2.80	2.80	0.60	31.46
		17	1.32	1.23	0.28	7.91	1.64	1.63	0.35	12.50	2.03	2.03	0.44	18.04	2.42	2.42	0.52	24.34	2.81	2.81	0.60	31.55
		19	-	-	-	-	2.40	1.63	0.52	24.05	2.40	2.03	0.52	24.03	2.55	2.42	0.55	26.54	2.82	2.81	0.61	31.75
		20	-	-	-	-	3.09	1.65	0.67	37.28	3.06	2.04	0.66	36.71	3.03	2.42	0.65	36.16	3.08	2.81	0.66	37.15
	5	15	1.07	1.07	0.18	2.63	1.45	1.45	0.25	5.71	1.83	1.83	0.32	10.29	2.23	2.23	0.38	14.38	2.62	2.62	0.45	19.10
		17	1.09	1.07	0.19	2.76	1.45	1.45	0.25	5.73	1.84	1.84	0.32	10.33	2.23	2.23	0.38	14.42	2.62	2.62	0.45	19.15
		19	-	-	-	-	1.85	1.43	0.32	10.52	2.01	1.84	0.35	12.16	2.27	2.24	0.39	14.99	2.63	2.63	0.45	19.21
		20	-	-	-	-	2.53	1.45	0.44	18.01	2.51	1.84	0.43	17.71	2.56	2.23	0.44	18.40	2.75	2.63	0.47	20.74
6	15	0.88	0.88	0.13	1.67	1.27	1.27	0.18	2.61	1.65	1.65	0.24	5.06	2.03	2.03	0.29	8.58	2.42	2.42	0.35	12.15	
	17	0.88	0.88	0.13	1.68	1.28	1.28	0.18	2.62	1.65	1.65	0.24	5.00	2.03	2.03	0.29	8.62	2.43	2.43	0.35	12.19	
	19	-	-	-	-	1.47	1.26	0.21	3.72	1.71	1.65	0.24	5.54	2.04	2.04	0.29	8.66	2.43	2.43	0.35	12.22	
	20	-	-	-	-	1.91	1.23	0.27	7.44	1.98	1.63	0.28	8.05	2.18	2.04	0.31	10.05	2.47	2.44	0.35	12.52	
13	3	15	1.03	1.03	0.30	9.00	1.43	1.43	0.41	16.27	1.83	1.83	0.53	24.61	2.21	2.21	0.63	33.82	2.60	2.60	0.75	45.25
		17	1.03	1.03	0.30	9.01	1.44	1.44	0.41	16.31	1.83	1.83	0.53	24.67	2.22	2.22	0.63	33.91	2.61	2.61	0.75	45.38
		19	-	-	-	-	1.85	1.43	0.53	25.07	1.94	1.83	0.56	27.10	2.22	2.22	0.63	34.04	2.61	2.61	0.75	45.51
		20	-	-	-	-	2.51	1.44	0.72	42.34	2.48	1.83	0.71	41.46	2.49	2.22	0.72	41.76	2.67	2.61	0.77	47.25
	4	15	0.85	0.85	0.18	2.63	1.23	1.23	0.26	6.86	1.63	1.63	0.35	12.27	2.03	2.03	0.44	17.91	2.42	2.42	0.52	24.14
		17	0.85	0.85	0.18	2.64	1.24	1.24	0.26	6.89	1.64	1.64	0.35	12.30	2.03	2.03	0.44	17.96	2.42	2.42	0.52	24.20
		19	-	-	-	-	1.37	1.23	0.29	8.91	1.66	1.64	0.36	12.61	2.04	2.04	0.44	18.01	2.42	2.42	0.52	24.27
		20	-	-	-	-	1.94	1.24	0.42	16.53	1.96	1.64	0.42	16.83	2.14	2.04	0.46	19.65	2.43	2.43	0.52	24.39
	5	15	0.66	0.66	0.11	1.46	1.06	1.06	0.18	2.59	1.44	1.44	0.25	5.83	1.83	1.83	0.31	10.17	2.23	2.23	0.38	14.18
		17	0.67	0.67	0.11	1.46	1.06	1.06	0.18	2.60	1.44	1.44	0.25	5.85	1.84	1.84	0.32	10.20	2.23	2.23	0.38	14.22
		19	-	-	-	-	1.11	1.06	0.19	2.90	1.45	1.44	0.25	5.87	1.84	1.84	0.32	10.23	2.23	2.23	0.38	14.26
		20	-	-	-	-	1.35	1.03	0.23	4.94	1.56	1.44	0.27	7.20	1.86	1.84	0.32	10.44	2.24	2.24	0.39	14.43
6	15	0.47	0.47	0.07	0.84	0.88	0.88	0.13	1.58	1.27	1.27	0.18	2.60	1.65	1.65	0.24	5.18	2.03	2.03	0.29	8.72	
	17	0.47	0.47	0.07	0.84	0.88	0.88	0.13	1.59	1.27	1.27	0.18	2.61	1.65	1.65	0.24	5.21	2.04	2.04	0.29	8.75	
	19	-	-	-	-	0.89	0.88	0.13	1.60	1.27	1.27	0.18	2.62	1.65	1.65	0.24	5.23	2.04	2.04	0.29	8.78	
	20	-	-	-	-	1.02	0.87	0.15	1.83	1.32	1.27	0.19	2.86	1.65	1.65	0.24	5.24	2.04	2.04	0.29	8.80	
15	3	15	0.64	0.64	0.18	2.61	1.03	1.03	0.29	8.92	1.43	1.43	0.41	16.02	1.82	1.82	0.52	23.83	2.21	2.21	0.63	33.22
		17	0.64	0.64	0.18	2.62	1.03	1.03	0.29	8.95	1.44	1.44	0.41	16.06	1.82	1.82	0.52	23.89	2.21	2.21	0.63	33.31
		19	-	-	-	-	1.04	1.04	0.30	9.06	1.44	1.44	0.41	16.11	1.83	1.83	0.52	23.96	2.22	2.22	0.63	33.41
		20	-	-	-	-	1.32	1.03	0.38	13.82	1.51	1.44	0.43	17.50	1.83	1.82	0.52	23.98	2.22	2.22	0.63	33.46
	4	15	0.45	0.45	0.10	1.20	0.85	0.85	0.18	2.63	1.24	1.24	0.26	7.08	1.64	1.64	0.35	12.25	2.02	2.02	0.43	17.43
		17	0.45	0.45	0.10	1.20	0.85	0.85	0.18	2.64	1.24	1.24	0.27	7.11	1.64	1.64	0.35	12.29	2.03	2.03	0.43	17.47
		19	-	-	-	-	0.85	0.85	0.18	2.65	1.24	1.24	0.27	7.14	1.64	1.64	0.35	12.32	2.03	2.03	0.44	17.52
		20	-	-	-	-	0.93	0.85	0.20	3.35	1.24	1.24	0.27	7.21	1.64	1.64	0.35	12.34	2.03	2.03	0.44	17.55
	5	15	0.25	0.25	0.04	0.52	0.67	0.67	0.11	1.40	1.06	1.06	0.18	2.68	1.44	1.44	0.25	6.11	1.84	1.84	0.32	10.16
		17	0.25	0.25	0.04	0.52	0.67	0.67	0.12	1.41	1.06	1.06	0.18	2.69	1.45	1.45	0.25	6.13	1.84	1.84	0.32	10.19
		19	-	-	-	-	0.67	0.67	0.12	1.41	1.07	1.07	0.18	2.70	1.45	1.45	0.25	6.16	1.84	1.84	0.32	10.22
		20	-	-	-	-	0.69	0.67	0.12	1.44	1.07	1.06	0.18	2.71	1.45	1.45	0.25	6.17	1.85	1.85	0.32	10.23
6	15	-	-	-	-	0.47	0.47	0.07	0.80	0.88	0.88	0.13	1.51	1.27	1.27	0.18	2.68	1.65	1.65	0.24	5.42	
	17	-	-	-	-	0.47	0.47	0.07	0.80	0.88	0.88	0.13	1.52	1.27	1.27	0.18	2.69	1.65	1.65	0.24	5.44	
	19	-	-	-	-	0.47	0.47	0.07	0.81	0.88	0.88	0.13	1.52	1.27	1.27	0.18	2.70	1.65	1.65	0.24	5.47	
	20	-	-	-	-	0.47	0.47	0.07	0.81	0.88	0.88	0.13	1.52	1.27	1.27	0.18	2.71	1.65	1.65	0.24	5.48	

Cooling Capacity

MKG-600-BA/ MKG-600A																							
EWT	ΔT	Indoor temp (W.B.)	Indoor temperature (D.B.)																				
			21				23				25				27				29				
			TC	SC	WF	WPD	TC	SC	WF	WPD	TC	SC	WF	WPD	TC	SC	WF	WPD	TC	SC	WF	WPD	
°C	°C	°C	kW	kW	m ³ /h	kPa	kW	kW	m ³ /h	kPa	kW	kW	m ³ /h	kPa	kW	kW	m ³ /h	kPa	kW	kW	m ³ /h	kPa	
5	3	15	3.90	3.01	1.12	96.30	3.87	3.44	1.11	94.93	3.96	3.89	1.14	98.86	4.32	4.32	1.25	117.04	4.75	4.75	1.36	135.57	
		17	5.20	3.02	1.50	159.89	5.17	3.46	1.49	158.27	5.14	3.89	1.48	156.55	5.11	4.33	1.47	154.89	5.08	4.76	1.47	153.49	
		19	-	-	-	-	6.57	3.47	1.90	240.22	6.53	3.91	1.88	237.86	6.50	4.34	1.87	235.50	6.46	4.77	1.86	233.22	
		20	-	-	-	-	7.31	3.47	2.11	289.67	7.27	3.91	2.10	286.93	7.23	4.35	2.09	284.21	7.19	4.78	2.08	281.48	
	4	15	3.42	2.79	0.73	46.32	3.46	3.23	0.74	47.16	3.69	3.68	0.80	53.10	4.12	4.12	0.89	64.31	4.55	4.55	0.98	76.42	
		17	4.74	2.80	1.02	81.35	4.71	3.24	1.01	80.44	4.68	3.68	1.01	79.53	4.65	4.11	1.00	78.59	4.72	4.55	1.01	80.70	
		19	-	-	-	-	6.11	3.26	1.32	127.05	6.08	3.70	1.32	126.54	6.04	4.13	1.31	124.85	6.01	4.56	1.30	123.94	
		20	-	-	-	-	6.87	3.27	1.49	157.31	6.83	3.70	1.48	155.74	6.79	4.14	1.47	154.31	6.75	4.57	1.47	152.71	
	5	15	2.95	2.57	0.51	24.31	3.12	3.02	0.54	26.87	3.47	3.47	0.60	32.38	3.90	3.90	0.67	39.69	4.33	4.33	0.74	47.13	
		17	4.25	2.58	0.73	45.56	4.22	3.02	0.72	44.99	4.19	3.46	0.72	44.37	4.23	3.90	0.73	45.10	4.41	4.34	0.76	48.53	
		19	-	-	-	-	5.64	3.04	0.97	74.17	5.60	3.48	0.97	73.63	5.57	3.92	0.96	73.03	5.54	4.35	0.96	72.58	
		20	-	-	-	-	6.38	3.05	1.10	92.07	6.34	3.49	1.09	91.13	6.31	3.92	1.09	90.22	6.27	4.36	1.08	89.29	
	6	15	2.55	2.35	0.37	13.74	2.83	2.80	0.40	16.56	3.25	3.25	0.46	20.97	3.69	3.69	0.53	26.04	4.13	4.13	0.59	31.75	
		17	3.74	2.36	0.53	26.59	3.70	2.80	0.53	26.17	3.72	3.25	0.53	26.36	3.87	3.69	0.55	28.30	4.16	4.14	0.60	32.12	
		19	-	-	-	-	5.14	2.83	0.74	46.27	5.11	3.27	0.73	45.76	5.08	3.70	0.73	45.22	5.04	4.13	0.72	44.65	
		20	-	-	-	-	5.88	2.83	0.84	57.93	5.85	3.27	0.84	57.32	5.81	3.71	0.83	56.71	5.77	4.14	0.83	56.11	
	7	3	15	2.91	2.55	0.84	57.53	3.05	3.01	0.88	62.61	3.44	3.44	0.99	76.68	3.88	3.88	1.12	94.51	4.31	4.31	1.24	113.74
			17	4.22	2.57	1.23	111.14	4.19	3.01	1.21	108.96	4.15	3.44	1.20	106.41	4.15	3.88	1.20	106.27	4.33	4.32	1.25	114.97
			19	-	-	-	-	5.59	3.02	1.63	182.24	5.56	3.46	1.62	180.43	5.53	3.90	1.61	178.57	5.49	4.33	1.60	176.70
			20	-	-	-	-	6.33	3.02	1.85	226.40	6.30	3.47	1.84	224.08	6.26	3.90	1.83	221.91	6.22	4.33	1.82	219.69
		4	15	2.50	2.34	0.54	26.70	2.80	2.79	0.61	32.72	3.24	3.24	0.70	41.98	3.67	3.67	0.80	52.22	4.11	4.11	0.89	63.35
			17	3.72	2.35	0.81	53.37	3.69	2.79	0.80	52.55	3.67	3.23	0.80	52.20	3.80	3.68	0.82	55.47	4.11	4.11	0.89	63.45
			19	-	-	-	-	5.10	2.81	1.11	92.56	5.07	3.25	1.10	91.57	5.04	3.69	1.09	90.53	5.00	4.12	1.09	89.31
			20	-	-	-	-	5.85	2.81	1.27	117.57	5.81	3.26	1.26	116.28	5.78	3.69	1.26	115.08	5.73	4.12	1.24	112.33
5		15	2.17	2.12	0.37	14.27	2.57	2.57	0.44	19.08	3.02	3.02	0.52	25.06	3.46	3.46	0.60	31.91	3.89	3.89	0.67	38.74	
		17	3.19	2.13	0.55	27.66	3.17	2.57	0.55	27.35	3.27	3.02	0.56	28.89	3.51	3.46	0.60	32.37	3.90	3.90	0.67	38.86	
		19	-	-	-	-	4.58	2.59	0.79	51.13	4.56	3.03	0.79	51.10	4.61	3.68	0.83	51.00	4.50	3.90	0.78	50.09	
		20	-	-	-	-	5.33	2.59	0.92	66.52	5.29	3.04	0.91	65.76	5.26	3.47	0.91	65.04	5.22	3.91	0.90	64.46	
6		15	1.91	1.90	0.27	6.96	2.35	2.35	0.34	11.64	2.80	2.80	0.40	16.12	3.25	3.25	0.47	20.75	3.69	3.69	0.53	25.85	
		17	2.60	1.89	0.37	14.12	2.68	2.35	0.38	14.95	2.92	2.81	0.42	17.28	3.26	3.25	0.47	20.86	3.69	3.69	0.53	25.92	
		19	-	-	-	-	4.03	2.36	0.58	29.87	3.99	2.81	0.57	29.40	3.98	3.24	0.57	29.17	4.07	3.69	0.58	30.35	
		20	-	-	-	-	4.80	2.38	0.69	40.61	4.76	2.82	0.68	39.73	4.72	3.26	0.68	39.19	4.69	3.69	0.67	38.67	
9		3	15	2.12	2.11	0.61	32.62	2.56	2.56	0.74	45.72	2.99	2.99	0.86	59.35	3.44	3.44	1.00	76.03	3.87	3.87	1.13	94.16
			17	3.14	2.11	0.90	64.50	3.11	2.55	0.90	63.35	3.17	3.00	0.91	65.40	3.44	3.44	1.00	76.16	3.88	3.88	1.13	94.34
			19	-	-	-	-	4.54	2.57	1.32	124.55	4.50	3.01	1.30	121.05	4.46	3.44	1.29	119.48	4.43	3.88	1.28	117.83
			20	-	-	-	-	5.27	2.57	1.53	160.09	5.24	3.01	1.52	158.43	5.20	3.45	1.51	156.67	5.17	3.89	1.50	155.00
		4	15	1.89	1.89	0.41	16.35	2.34	2.34	0.51	23.79	2.78	2.78	0.60	31.67	3.23	3.23	0.70	41.25	3.66	3.66	0.79	51.31
			17	2.58	1.88	0.56	27.91	2.63	2.34	0.57	28.61	2.85	2.79	0.61	32.94	3.24	3.23	0.70	41.37	3.67	3.67	0.80	51.46
			19	-	-	-	-	3.99	2.35	0.86	58.98	3.96	2.79	0.85	58.13	3.94	3.23	0.85	58.17	3.98	3.67	0.86	58.54
			20	-	-	-	-	4.74	2.35	1.02	79.51	4.71	2.80	1.02	78.57	4.68	3.24	1.01	77.64	4.64	3.67	1.00	76.54
	5	15	1.67	1.67	0.29	8.04	2.12	2.12	0.37	13.54	2.57	2.57	0.44	18.79	3.02	3.02	0.52	24.65	3.45	3.45	0.59	31.07	
		17	2.03	1.66	0.35	12.52	2.25	2.12	0.39	15.07	2.58	2.58	0.45	18.95	3.02	3.02	0.52	24.72	3.46	3.46	0.60	31.16	
		19	-	-	-	-	3.43	2.13	0.59	30.66	3.40	2.57	0.59	30.19	3.44	3.02	0.59	30.86	3.63	3.47	0.63	33.89	
		20	-	-	-	-	4.19	2.14	0.72	43.25	4.16	2.58	0.72	42.84	4.13	3.03	0.72	42.55	4.12	3.46	0.71	42.33	
	6	15	1.47	1.47	0.21	3.53	1.90	1.90	0.27	7.14	2.35	2.35	0.34	11.69	2.80	2.80	0.40	15.84	3.24	3.24	0.47	20.33	
		17	1.64	1.45	0.24	4.79	1.94	1.90	0.28	7.57	2.36	2.35	0.34	11.73	2.80	2.80	0.40	15.89	3.25	3.25	0.47	20.39	
		19	-	-	-	-	2.81	1.90	0.40	15.94	2.85	2.35	0.41	16.34	3.04	2.80	0.44	18.21	3.32	3.25	0.48	21.14	
		20	-	-	-	-	3.60	1.91	0.52	24.22	3.56	2.36	0.51	23.79	3.55	2.80	0.51	23.66	3.66	3.25	0.52	24.93	

Continued:

		MKG-600-BA/ MKG-600A																				
EWT	ΔT	Indoor temp (W.B.)	Indoor temperature (D.B.)																			
			21				23				25				27				29			
			TC	SC	WF	WPD	TC	SC	WF	WPD	TC	SC	WF	WPD	TC	SC	WF	WPD	TC	SC	WF	WPD
°C	°C	°C	kW	kW	m³/h	kPa	kW	kW	m³/h	kPa	kW	kW	m³/h	kPa	kW	kW	m³/h	kPa	kW	kW	m³/h	kPa
11	3	15	1.65	1.65	0.47	20.78	2.10	2.10	0.60	31.38	2.55	2.55	0.73	43.68	2.99	2.99	0.85	57.60	3.42	3.42	0.98	73.18
		17	1.99	1.65	0.57	28.59	2.17	2.11	0.62	33.21	2.55	2.55	0.73	43.80	2.99	2.99	0.86	57.77	3.43	3.43	0.98	73.26
		19	-	-	-	-	3.39	2.11	0.98	72.83	3.36	2.56	0.97	71.55	3.36	3.00	0.97	71.47	3.51	3.44	1.01	76.39
		20	-	-	-	-	4.15	2.12	1.20	103.46	4.11	2.56	1.19	102.09	4.07	3.00	1.17	99.81	4.05	3.44	1.17	99.22
	4	15	1.43	1.43	0.31	9.59	1.89	1.89	0.40	15.91	2.34	2.34	0.50	22.90	2.78	2.78	0.60	31.04	3.22	3.22	0.69	39.69
		17	1.55	1.43	0.33	11.37	1.90	1.89	0.41	16.06	2.34	2.34	0.50	22.97	2.79	2.79	0.60	31.14	3.22	3.22	0.69	39.81
		19	-	-	-	-	2.80	1.89	0.60	31.31	2.80	2.34	0.60	31.38	2.96	2.79	0.64	34.71	3.24	3.23	0.70	40.24
		20	-	-	-	-	3.56	1.90	0.76	47.20	3.54	2.35	0.77	47.54	3.50	2.78	0.75	45.75	3.56	3.23	0.76	47.18
	5	15	1.23	1.23	0.21	3.65	1.67	1.67	0.29	8.31	2.12	2.12	0.36	13.22	2.57	2.57	0.44	18.51	3.01	3.01	0.52	24.26
		17	1.26	1.23	0.22	3.97	1.67	1.67	0.29	8.34	2.12	2.12	0.36	13.26	2.58	2.58	0.44	18.57	3.02	3.02	0.52	24.33
		19	-	-	-	-	2.18	1.66	0.37	13.81	2.36	2.13	0.41	16.00	2.64	2.58	0.46	19.37	3.02	3.02	0.52	24.40
		20	-	-	-	-	2.95	1.68	0.51	23.30	2.92	2.12	0.50	22.97	2.99	2.58	0.52	23.95	3.19	3.02	0.55	26.64
6	15	1.01	1.01	0.15	1.93	1.46	1.46	0.21	3.65	1.90	1.90	0.27	7.29	2.35	2.35	0.34	11.51	2.80	2.80	0.40	15.62	
	17	1.02	1.02	0.15	1.94	1.47	1.47	0.21	3.67	1.90	1.90	0.27	7.32	2.35	2.35	0.34	11.55	2.81	2.81	0.40	15.67	
	19	-	-	-	-	1.70	1.44	0.24	5.49	1.99	1.90	0.28	8.21	2.37	2.36	0.34	11.64	2.81	2.81	0.40	15.72	
	20	-	-	-	-	2.26	1.43	0.32	10.69	2.34	1.89	0.33	11.38	2.57	2.36	0.37	13.42	2.88	2.81	0.41	16.36	
13	3	15	1.19	1.19	0.34	11.93	1.65	1.65	0.47	20.71	2.10	2.10	0.60	30.82	2.54	2.54	0.73	43.26	2.98	2.98	0.85	56.57
		17	1.20	1.19	0.34	11.98	1.65	1.65	0.48	20.77	2.10	2.10	0.60	30.91	2.55	2.55	0.73	43.38	2.99	2.99	0.85	56.74
		19	-	-	-	-	2.14	1.65	0.61	31.79	2.26	2.11	0.65	34.95	2.56	2.56	0.73	43.70	2.99	2.99	0.86	56.91
		20	-	-	-	-	2.89	1.65	0.83	53.67	2.86	2.10	0.82	52.60	2.88	2.55	0.82	53.23	3.08	3.00	0.89	60.57
	4	15	0.98	0.98	0.21	3.75	1.43	1.43	0.31	9.66	1.89	1.89	0.41	15.85	2.34	2.34	0.50	22.75	2.77	2.77	0.59	30.27
		17	0.98	0.98	0.21	3.76	1.43	1.43	0.31	9.69	1.89	1.89	0.41	15.89	2.34	2.34	0.50	22.82	2.78	2.78	0.60	30.36
		19	-	-	-	-	1.62	1.43	0.35	12.15	1.94	1.90	0.42	16.56	2.34	2.34	0.51	22.89	2.78	2.78	0.60	30.46
		20	-	-	-	-	2.25	1.43	0.49	21.37	2.28	1.89	0.49	21.90	2.49	2.34	0.54	25.42	2.80	2.79	0.60	30.76
	5	15	0.77	0.77	0.13	1.68	1.22	1.22	0.21	3.70	1.66	1.66	0.29	8.35	2.12	2.12	0.36	13.02	2.57	2.57	0.44	18.19
		17	0.77	0.77	0.13	1.69	1.22	1.22	0.21	3.72	1.67	1.67	0.29	8.38	2.12	2.12	0.36	13.06	2.57	2.57	0.44	18.24
		19	-	-	-	-	1.29	1.22	0.22	4.29	1.67	1.67	0.29	8.43	2.13	2.13	0.36	13.11	2.58	2.58	0.44	18.30
		20	-	-	-	-	1.59	1.20	0.27	7.49	1.84	1.67	0.32	10.22	2.17	2.13	0.37	13.57	2.58	2.58	0.44	18.33
6	15	0.54	0.54	0.08	0.96	1.01	1.01	0.14	1.82	1.46	1.46	0.21	3.72	1.90	1.90	0.27	7.48	2.35	2.35	0.34	11.46	
	17	0.54	0.54	0.08	0.96	1.01	1.01	0.14	1.82	1.46	1.46	0.21	3.74	1.90	1.90	0.27	7.52	2.36	2.36	0.34	11.50	
	19	-	-	-	-	1.03	1.02	0.15	1.86	1.46	1.46	0.21	3.76	1.91	1.91	0.27	7.55	2.36	2.36	0.34	11.53	
	20	-	-	-	-	1.19	1.00	0.17	2.28	1.53	1.46	0.22	4.22	1.91	1.91	0.27	7.59	2.37	2.37	0.34	11.55	
15	3	15	0.74	0.74	0.21	3.77	1.19	1.19	0.34	11.57	1.65	1.65	0.47	20.36	2.09	2.09	0.60	30.27	2.54	2.54	0.73	42.17
		17	0.74	0.74	0.21	3.79	1.19	1.19	0.34	11.60	1.65	1.65	0.48	20.42	2.10	2.10	0.60	30.36	2.54	2.54	0.73	42.30
		19	-	-	-	-	1.21	1.20	0.35	11.86	1.65	1.65	0.48	20.48	2.10	2.10	0.60	30.46	2.54	2.54	0.73	42.43
		20	-	-	-	-	1.56	1.19	0.45	18.49	1.75	1.65	0.50	22.25	2.10	2.10	0.60	30.53	2.55	2.55	0.73	42.50
	4	15	0.52	0.52	0.11	1.38	0.98	0.98	0.21	3.81	1.43	1.43	0.31	9.78	1.89	1.89	0.41	15.58	2.33	2.33	0.50	22.13
		17	0.52	0.52	0.11	1.38	0.98	0.98	0.21	3.82	1.44	1.44	0.31	9.81	1.89	1.89	0.41	15.63	2.33	2.33	0.50	22.20
		19	-	-	-	-	0.98	0.98	0.21	3.84	1.44	1.44	0.31	9.84	1.89	1.89	0.41	15.68	2.34	2.34	0.50	22.27
		20	-	-	-	-	1.08	0.98	0.23	5.03	1.45	1.44	0.31	10.01	1.89	1.89	0.41	15.71	2.34	2.34	0.50	22.30
	5	15	0.28	0.28	0.05	0.59	0.77	0.77	0.13	1.61	1.22	1.22	0.21	3.89	1.67	1.67	0.29	8.51	2.12	2.12	0.37	12.93
		17	0.28	0.28	0.05	0.59	0.77	0.77	0.13	1.62	1.22	1.22	0.21	3.91	1.67	1.67	0.29	8.55	2.12	2.12	0.37	12.96
		19	-	-	-	-	0.77	0.77	0.13	1.62	1.22	1.22	0.21	3.93	1.67	1.67	0.29	8.58	2.13	2.13	0.37	13.01
		20	-	-	-	-	0.80	0.77	0.14	1.68	1.22	1.22	0.21	3.93	1.67	1.67	0.29	8.60	2.13	2.13	0.37	13.03
6	15	-	-	-	-	0.54	0.54	0.08	0.92	1.01	1.01	0.15	1.75	1.46	1.46	0.21	3.89	1.90	1.90	0.27	7.57	
	17	-	-	-	-	0.54	0.54	0.08	0.92	1.01	1.01	0.15	1.75	1.46	1.46	0.21	3.91	1.90	1.90	0.27	7.60	
	19	-	-	-	-	0.54	0.54	0.08	0.92	1.01	1.01	0.15	1.75	1.46	1.46	0.21	3.93	1.90	1.90	0.27	7.63	
	20	-	-	-	-	0.54	0.54	0.08	0.92	1.02	1.02	0.15	1.76	1.46	1.46	0.21	3.94	1.90	1.90	0.27	7.65	

Heating Capacity

Δt: Temperature Difference (°C) **TH:** Total Heating Capacity (kW) **WF:** Water Flow (m³/h) **WPD:** Water Pressure Drop (kPa)

MKG-250-BA/MKG-250A													
EWT	ΔT	Indoor temperature (W.B.)											
		16			18			20			22		
		TH	WF	WPD	TH	WF	WPD	TH	WF	WPD	TH	WF	WPD
°C	°C	kW	m ³ /h	kPa	kW	m ³ /h	kPa	kW	m ³ /h	kPa	kW	m ³ /h	kPa
40	8	1.87	0.20	3.05	1.64	0.18	2.25	1.41	0.15	1.50	1.18	0.13	0.94
	10	1.66	0.14	1.25	1.43	0.12	0.87	1.20	0.10	0.66	0.97	0.08	0.53
	12	1.44	0.10	0.69	1.21	0.09	0.57	0.97	0.07	0.46	0.74	0.05	0.35
	14	1.22	0.07	0.51	0.98	0.06	0.41	0.74	0.05	0.32	0.51	0.03	0.22
	16	0.99	0.05	0.38	0.75	0.04	0.29	0.51	0.03	0.20	0.27	0.01	0.11
45	8	2.48	0.27	4.79	2.23	0.24	4.03	1.99	0.22	3.32	1.76	0.19	2.67
	10	2.24	0.19	2.78	2.00	0.17	2.19	1.77	0.15	1.60	1.54	0.13	1.10
	12	2.02	0.15	1.38	1.79	0.13	0.99	1.56	0.11	0.72	1.33	0.10	0.57
	14	1.81	0.11	0.72	1.57	0.10	0.60	1.34	0.08	0.51	1.10	0.07	0.42
	16	1.58	0.09	0.54	1.35	0.07	0.46	1.11	0.06	0.38	0.87	0.05	0.30
50	8	3.07	0.33	6.75	2.83	0.31	5.86	2.59	0.28	5.04	2.35	0.25	4.27
	10	2.85	0.25	4.09	2.60	0.23	3.52	2.36	0.20	2.98	2.12	0.18	2.49
	12	2.61	0.19	2.60	2.37	0.17	2.15	2.13	0.15	1.68	1.89	0.14	1.24
	14	2.38	0.15	1.49	2.15	0.13	1.13	1.92	0.12	0.83	1.69	0.10	0.62
	16	2.17	0.12	0.80	1.94	0.10	0.63	1.70	0.09	0.53	1.47	0.08	0.46
55	8	3.66	0.39	8.94	3.42	0.37	7.94	3.18	0.34	7.00	2.94	0.32	6.11
	10	3.44	0.30	5.53	3.20	0.28	4.88	2.96	0.26	4.27	2.72	0.23	3.69
	12	3.22	0.23	3.62	2.97	0.21	3.16	2.73	0.20	2.74	2.49	0.18	2.34
	14	2.98	0.18	2.48	2.74	0.17	2.13	2.49	0.15	1.75	2.26	0.14	1.38
	16	2.75	0.15	1.58	2.51	0.14	1.25	2.28	0.12	0.96	2.05	0.11	0.72
60	8	4.26	0.46	11.36	4.01	0.43	10.24	3.77	0.41	9.24	3.53	0.38	8.24
	10	4.04	0.35	7.09	3.79	0.33	6.36	3.55	0.31	5.68	3.31	0.29	5.03
	12	3.82	0.27	4.75	3.57	0.26	4.24	3.33	0.24	3.74	3.08	0.22	3.29
	14	3.59	0.22	3.30	3.34	0.21	2.92	3.10	0.19	2.57	2.86	0.18	2.24
	16	3.36	0.18	2.36	3.11	0.17	2.08	2.86	0.15	1.78	2.62	0.14	1.47

Heating Capacity

Δt: Temperature Difference (°C) **TH:** Total Heating Capacity (kW) **WF:** Water Flow (m³/h) **WPD:** Water Pressure Drop (kPa)

MKG-300-BA/ MKG-300A													
EWT	ΔT	Indoor temperature (W.B.)											
		16			18			20			22		
		TH	WF	WPD	TH	WF	WPD	TH	WF	WPD	TH	WF	WPD
°C	°C	kW	m ³ /h	kPa	kW	m ³ /h	kPa	kW	m ³ /h	kPa	kW	m ³ /h	kPa
40	8	2.35	0.25	4.51	2.05	0.22	3.59	1.76	0.19	2.66	1.47	0.16	1.69
	10	2.06	0.18	2.26	1.78	0.15	1.51	1.49	0.13	0.96	1.21	0.10	0.67
	12	1.80	0.13	0.97	1.51	0.11	0.73	1.22	0.09	0.58	0.93	0.07	0.44
	14	1.53	0.09	0.64	1.23	0.08	0.52	0.93	0.06	0.40	0.64	0.04	0.27
	16	1.24	0.07	0.48	0.95	0.05	0.37	0.64	0.03	0.25	0.33	0.02	0.13
45	8	3.09	0.33	6.98	2.79	0.30	5.87	2.49	0.27	4.85	2.20	0.24	3.92
	10	2.81	0.24	4.09	2.51	0.22	3.38	2.21	0.19	2.71	1.91	0.17	1.97
	12	2.52	0.18	2.43	2.22	0.16	1.79	1.93	0.14	1.23	1.65	0.12	0.81
	14	2.25	0.14	1.19	1.96	0.12	0.84	1.67	0.10	0.64	1.38	0.08	0.53
	16	1.98	0.11	0.69	1.69	0.09	0.58	1.40	0.08	0.48	1.09	0.06	0.38
50	8	3.82	0.41	9.81	3.52	0.38	8.53	3.22	0.35	7.33	2.92	0.32	6.21
	10	3.55	0.31	5.96	3.25	0.28	5.12	2.95	0.25	4.35	2.65	0.23	3.63
	12	3.26	0.23	3.81	2.96	0.21	3.24	2.66	0.19	2.70	2.36	0.17	2.15
	14	2.98	0.18	2.50	2.68	0.17	1.99	2.38	0.15	1.49	2.10	0.13	1.05
	16	2.70	0.15	1.43	2.41	0.13	1.05	2.12	0.11	0.76	1.83	0.10	0.58
55	8	4.55	0.49	12.99	4.24	0.46	11.54	3.95	0.43	10.16	3.65	0.39	8.88
	10	4.28	0.37	8.04	3.98	0.34	7.09	3.68	0.32	6.20	3.38	0.29	5.37
	12	4.01	0.29	5.27	3.70	0.27	4.61	3.40	0.24	3.99	3.10	0.22	3.41
	14	3.73	0.23	3.62	3.43	0.21	3.14	3.13	0.19	2.68	2.82	0.17	2.25
	16	3.44	0.19	2.53	3.14	0.17	2.13	2.84	0.15	1.70	2.54	0.14	1.29
60	8	5.28	0.57	16.60	4.98	0.54	14.97	4.67	0.50	13.35	4.37	0.47	11.90
	10	5.01	0.43	10.30	4.71	0.41	9.25	4.41	0.38	8.25	4.11	0.35	7.30
	12	4.75	0.34	6.90	4.44	0.32	6.16	4.14	0.30	5.46	3.84	0.28	4.80
	14	4.47	0.28	4.80	4.17	0.26	4.26	3.86	0.24	3.74	3.56	0.22	3.26
	16	4.20	0.23	3.46	3.89	0.21	3.03	3.58	0.19	2.64	3.28	0.18	2.28

Heating Capacity**Δt:** Temperature Difference (°C) **TH:** Total Heating Capacity (kW) **WF:** Water Flow (m³/h) **WPD:** Water Pressure Drop (kPa)

MKG-400-BA/ MKG-400A													
EWT	ΔT	Indoor temperature (W.B.)											
		16			18			20			22		
		TH	WF	WPD	TH	WF	WPD	TH	WF	WPD	TH	WF	WPD
°C	°C	kW	m ³ /h	kPa	kW	m ³ /h	kPa	kW	m ³ /h	kPa	kW	m ³ /h	kPa
40	8	2.84	0.31	6.23	2.49	0.27	4.97	2.13	0.23	3.83	1.78	0.19	2.74
	10	2.50	0.22	3.46	2.15	0.19	2.49	1.80	0.16	1.57	1.47	0.13	0.92
	12	2.18	0.16	1.57	1.84	0.13	1.00	1.49	0.11	0.71	1.13	0.08	0.54
	14	1.86	0.11	0.79	1.50	0.09	0.63	1.15	0.07	0.49	0.78	0.05	0.33
	16	1.52	0.08	0.58	1.16	0.06	0.45	0.79	0.04	0.31	0.41	0.02	0.16
45	8	3.72	0.40	9.62	3.37	0.36	8.10	3.01	0.32	6.70	2.66	0.29	5.42
	10	3.40	0.29	5.66	3.04	0.26	4.68	2.68	0.23	3.79	2.33	0.20	2.98
	12	3.06	0.22	3.52	2.70	0.19	2.81	2.34	0.17	2.05	2.00	0.14	1.34
	14	2.72	0.17	1.97	2.37	0.15	1.37	2.03	0.13	0.91	1.68	0.10	0.65
	16	2.41	0.13	0.99	2.05	0.11	0.73	1.70	0.09	0.59	1.34	0.07	0.46
50	8	4.60	0.50	13.53	4.24	0.46	11.76	3.88	0.42	10.11	3.53	0.38	8.58
	10	4.28	0.37	8.22	3.92	0.34	7.08	3.57	0.31	6.02	3.21	0.28	5.03
	12	3.95	0.28	5.27	3.59	0.26	4.48	3.23	0.23	3.75	2.88	0.21	3.08
	14	3.62	0.22	3.52	3.26	0.20	2.94	2.89	0.18	2.36	2.54	0.16	1.75
	16	3.27	0.18	2.31	2.92	0.16	1.75	2.57	0.14	1.25	2.23	0.12	0.85
55	8	5.48	0.59	18.01	5.12	0.55	16.00	4.75	0.51	14.03	4.40	0.47	12.26
	10	5.16	0.45	11.10	4.80	0.41	9.79	4.44	0.38	8.57	4.09	0.35	7.42
	12	4.84	0.35	7.27	4.48	0.32	6.37	4.12	0.30	5.52	3.76	0.27	4.73
	14	4.52	0.28	5.01	4.16	0.26	4.35	3.79	0.23	3.72	3.43	0.21	3.15
	16	4.18	0.23	3.51	3.81	0.21	3.01	3.45	0.19	2.54	3.09	0.17	2.06
60	8	6.35	0.68	22.77	5.99	0.65	20.55	5.62	0.61	18.43	5.27	0.57	16.53
	10	6.04	0.52	14.28	5.68	0.49	12.76	5.31	0.46	11.39	4.95	0.43	10.10
	12	5.72	0.41	9.53	5.36	0.39	8.51	5.00	0.36	7.55	4.64	0.33	6.65
	14	5.40	0.33	6.64	5.04	0.31	5.89	4.68	0.29	5.19	4.32	0.27	4.52
	16	5.08	0.27	4.79	4.72	0.25	4.22	4.35	0.23	3.68	3.99	0.21	3.17

Heating Capacity

Δt: Temperature Difference (°C) **TH:** Total Heating Capacity (kW) **WF:** Water Flow (m³/h) **WPD:** Water Pressure Drop (kPa)

MKG-500-BA/MKG-500A													
EWT	ΔT	Indoor temperature (W.B.)											
		16			18			20			22		
		TH	WF	WPD	TH	WF	WPD	TH	WF	WPD	TH	WF	WPD
°C	°C	kW	m³/h	kPa	kW	m³/h	kPa	kW	m³/h	kPa	kW	m³/h	kPa
40	8	3.63	0.39	13.17	3.18	0.34	10.53	2.74	0.30	8.13	2.29	0.25	6.00
	10	3.22	0.28	7.37	2.77	0.24	5.71	2.32	0.20	4.11	1.88	0.16	2.43
	12	2.79	0.20	4.13	2.35	0.17	2.68	1.91	0.14	1.54	1.47	0.11	0.98
	14	2.39	0.15	1.79	1.94	0.12	1.17	1.49	0.09	0.88	1.02	0.06	0.61
	16	1.97	0.11	1.05	1.51	0.08	0.81	1.04	0.06	0.56	0.54	0.03	0.30
45	8	4.72	0.51	20.14	4.28	0.46	16.97	3.84	0.42	14.14	3.39	0.37	11.39
	10	4.33	0.37	11.89	3.88	0.34	9.87	3.44	0.30	8.01	2.99	0.26	6.32
	12	3.93	0.28	7.45	3.47	0.25	6.05	3.02	0.22	4.78	2.57	0.18	3.51
	14	3.50	0.22	4.74	3.04	0.19	3.59	2.60	0.16	2.42	2.16	0.13	1.47
	16	3.08	0.17	2.63	2.64	0.14	1.73	2.19	0.12	1.12	1.74	0.09	0.84
50	8	5.82	0.63	28.25	5.38	0.58	24.71	4.93	0.53	21.28	4.48	0.48	17.97
	10	5.44	0.47	17.23	4.99	0.43	14.85	4.54	0.39	12.63	4.10	0.35	10.58
	12	5.04	0.36	11.08	4.59	0.33	9.43	4.14	0.30	7.91	3.69	0.27	6.51
	14	4.63	0.29	7.43	4.18	0.26	6.23	3.72	0.23	5.13	3.27	0.20	4.12
	16	4.21	0.23	5.08	3.75	0.20	4.18	3.30	0.18	3.25	2.85	0.15	2.28
55	8	6.93	0.75	37.52	6.47	0.70	33.36	6.02	0.65	29.34	5.58	0.60	25.66
	10	6.54	0.56	23.11	6.09	0.52	20.41	5.64	0.49	17.87	5.19	0.45	15.49
	12	6.15	0.44	15.30	5.70	0.41	13.35	5.24	0.38	11.59	4.80	0.34	9.94
	14	5.76	0.36	10.53	5.30	0.33	9.14	4.85	0.30	7.85	4.40	0.27	6.64
	16	5.35	0.29	7.44	4.89	0.26	6.39	4.44	0.24	5.41	3.98	0.21	4.49
60	8	8.03	0.87	47.79	7.57	0.81	42.90	7.12	0.77	38.60	6.67	0.72	34.43
	10	7.65	0.66	29.77	7.19	0.62	26.81	6.74	0.58	23.95	6.28	0.54	21.23
	12	7.26	0.52	19.89	6.80	0.49	17.76	6.35	0.46	15.83	5.90	0.42	13.93
	14	6.87	0.42	13.91	6.41	0.39	12.36	5.96	0.37	10.89	5.50	0.34	9.51
	16	6.47	0.35	10.07	6.01	0.32	8.87	5.56	0.30	7.75	5.10	0.28	6.70

Heating Capacity

Δt: Temperature Difference (°C) **TH:** Total Heating Capacity (kW) **WF:** Water Flow (m³/h) **WPD:** Water Pressure Drop (kPa)

MKG-600-BA/ MKG-600A													
EWT	ΔT	Indoor temperature (W.B.)											
		16			18			20			22		
		TH	WF	WPD	TH	WF	WPD	TH	WF	WPD	TH	WF	WPD
°C	°C	kW	m ³ /h	kPa	kW	m ³ /h	kPa	kW	m ³ /h	kPa	kW	m ³ /h	kPa
40	8	3.76	0.41	13.99	3.30	0.36	11.20	2.84	0.31	8.68	2.38	0.26	6.40
	10	3.34	0.29	7.84	2.88	0.25	6.09	2.41	0.21	4.46	1.95	0.17	2.70
	12	2.90	0.21	4.49	2.44	0.18	2.97	1.99	0.14	1.71	1.54	0.11	1.03
	14	2.48	0.15	1.99	2.03	0.12	1.25	1.56	0.10	0.91	1.07	0.07	0.64
	16	2.06	0.11	1.10	1.58	0.09	0.84	1.09	0.06	0.59	0.58	0.03	0.31
45	8	4.90	0.53	21.38	4.44	0.48	18.04	3.98	0.43	15.04	3.52	0.38	12.13
	10	4.49	0.39	12.65	4.03	0.35	10.50	3.57	0.31	8.54	3.11	0.27	6.75
	12	4.08	0.29	7.93	3.61	0.26	6.45	3.14	0.23	5.11	2.67	0.19	3.83
	14	3.64	0.22	5.07	3.17	0.20	3.91	2.70	0.17	2.69	2.25	0.14	1.64
	16	3.20	0.17	2.91	2.74	0.15	1.93	2.29	0.12	1.22	1.82	0.10	0.88
50	8	6.03	0.65	29.99	5.57	0.60	26.25	5.11	0.55	22.61	4.65	0.50	19.12
	10	5.64	0.49	18.31	5.17	0.45	15.79	4.71	0.41	13.44	4.25	0.37	11.27
	12	5.23	0.38	11.79	4.76	0.34	10.05	4.30	0.31	8.43	3.83	0.28	6.95
	14	4.81	0.30	7.92	4.34	0.27	6.65	3.87	0.24	5.48	3.41	0.21	4.41
	16	4.38	0.24	5.42	3.91	0.21	4.47	3.44	0.19	3.54	2.97	0.16	2.54
55	8	7.17	0.77	39.92	6.70	0.72	35.42	6.24	0.67	31.18	5.78	0.62	27.29
	10	6.77	0.58	24.55	6.31	0.54	21.69	5.84	0.50	19.01	5.38	0.46	16.49
	12	6.38	0.46	16.27	5.91	0.43	14.27	5.44	0.39	12.34	4.98	0.36	10.60
	14	5.97	0.37	11.21	5.50	0.34	9.74	5.04	0.31	8.37	4.57	0.28	7.10
	16	5.56	0.30	7.93	5.08	0.27	6.82	4.61	0.25	5.78	4.14	0.22	4.80
60	8	8.31	0.90	50.70	7.84	0.84	45.55	7.37	0.79	40.91	6.91	0.74	36.62
	10	7.92	0.68	31.56	7.45	0.64	28.42	6.98	0.60	25.46	6.52	0.56	22.60
	12	7.52	0.54	21.14	7.05	0.51	18.90	6.59	0.47	16.85	6.12	0.44	14.85
	14	7.12	0.44	14.81	6.65	0.41	13.16	6.18	0.38	11.61	5.72	0.35	10.15
	16	6.72	0.36	10.72	6.25	0.34	9.46	5.78	0.31	8.28	5.31	0.29	7.17

7. Sound Levels

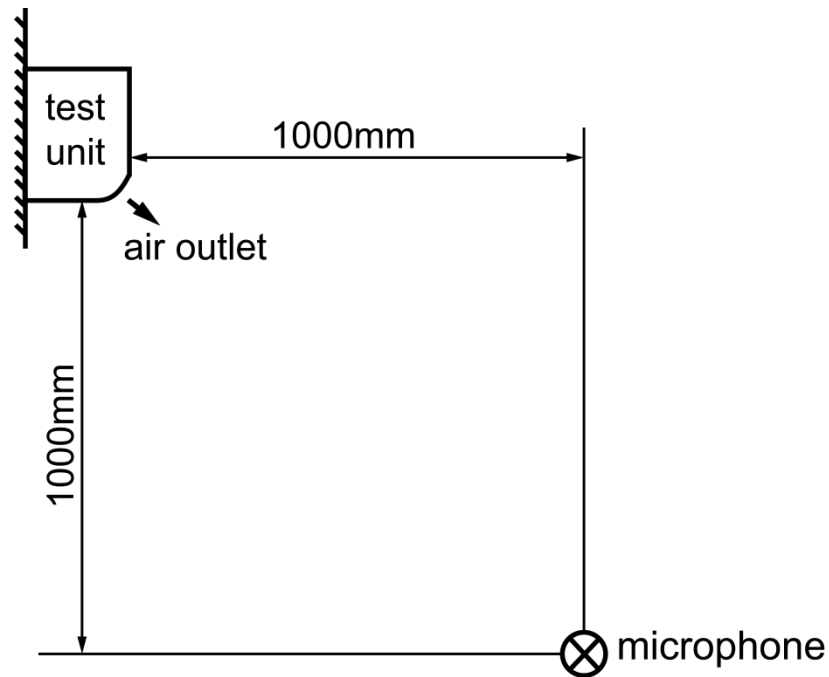

Series	Model	Noise level under three speeds of fan [dB(A)]		
		H	M	L
C panel	MKG-250	30	24	20
	MKG-300	35	29	24
	MKG-400	37	31	26
	MKG-500	39	33	28
	MKG-600	40	34	29
S panel	MKG-250-B	30	24	20
	MKG-300-B	35	29	24
	MKG-400-B	37	31	26
	MKG-500-B	39	33	28
	MKG-600-B	40	34	29

MKG-250BA

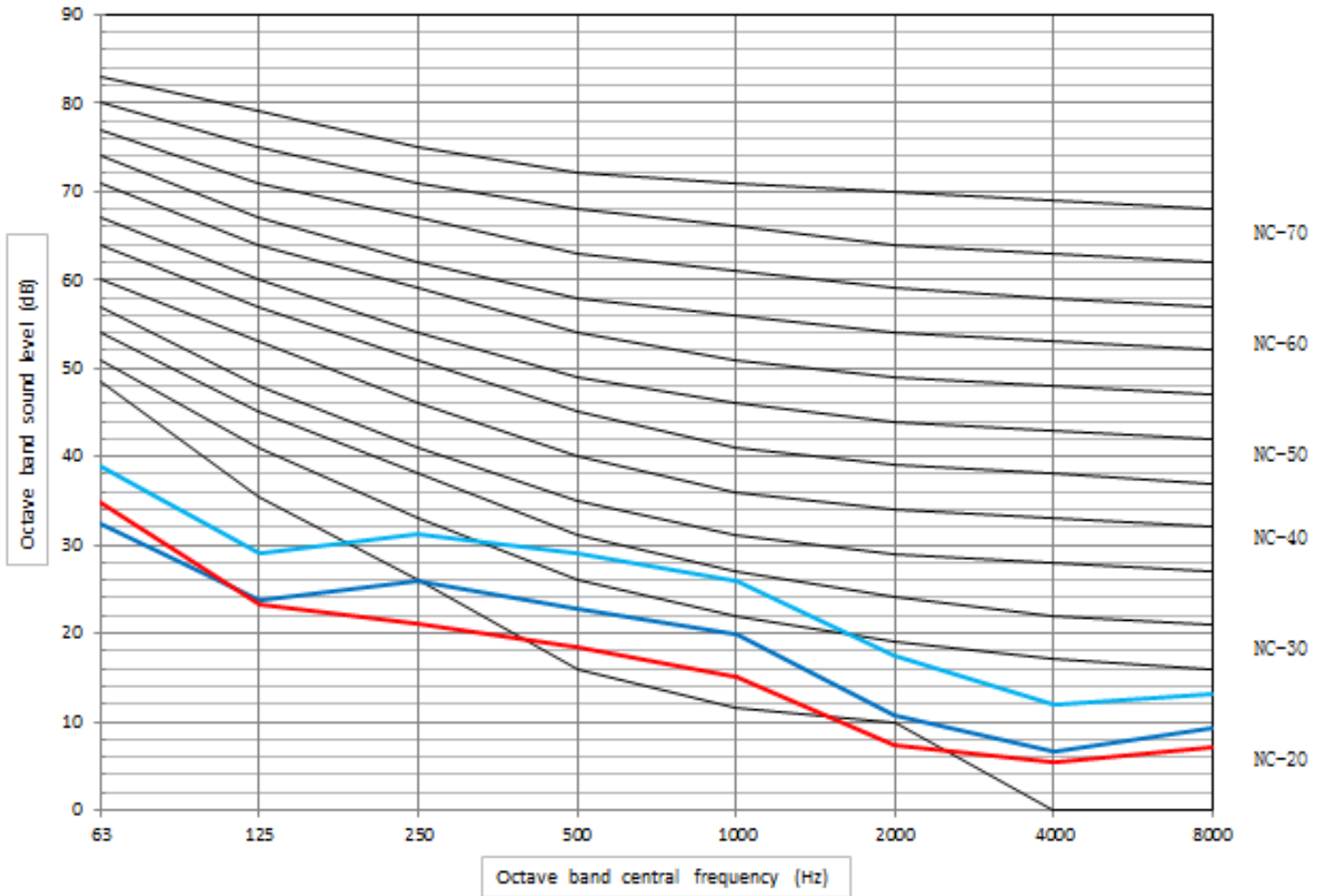

MKG-300BA

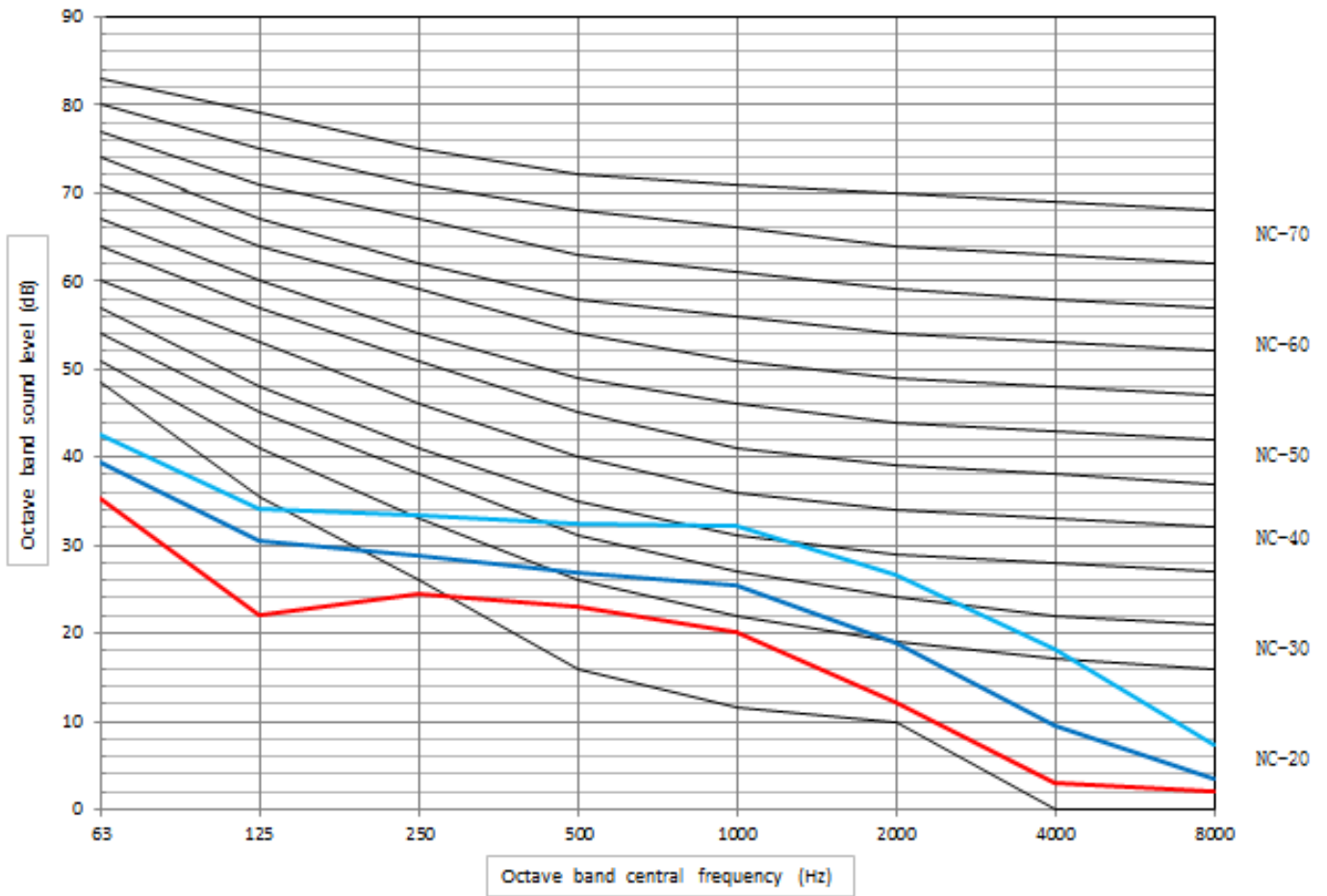

MKG-400BA

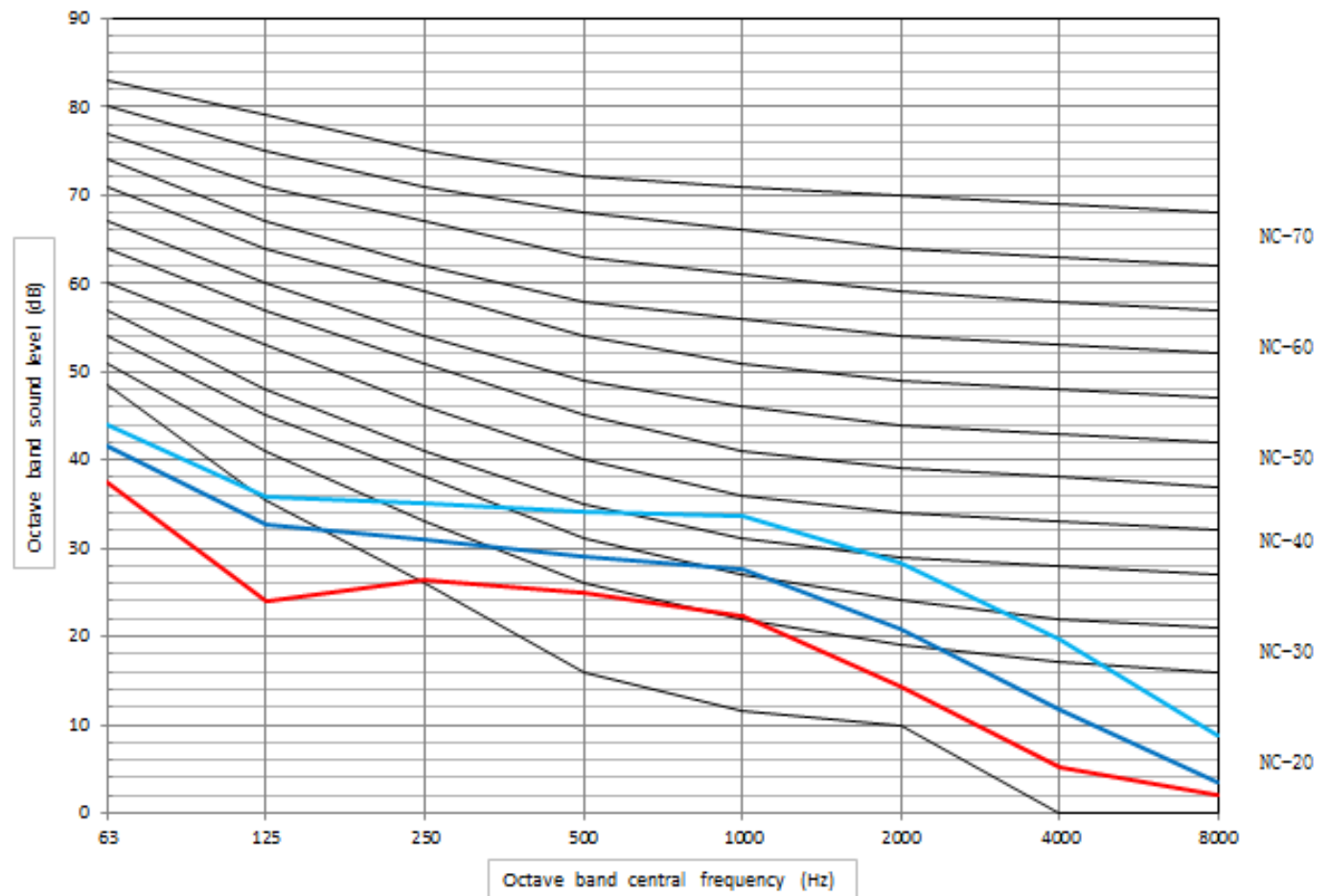

MKG-500BA

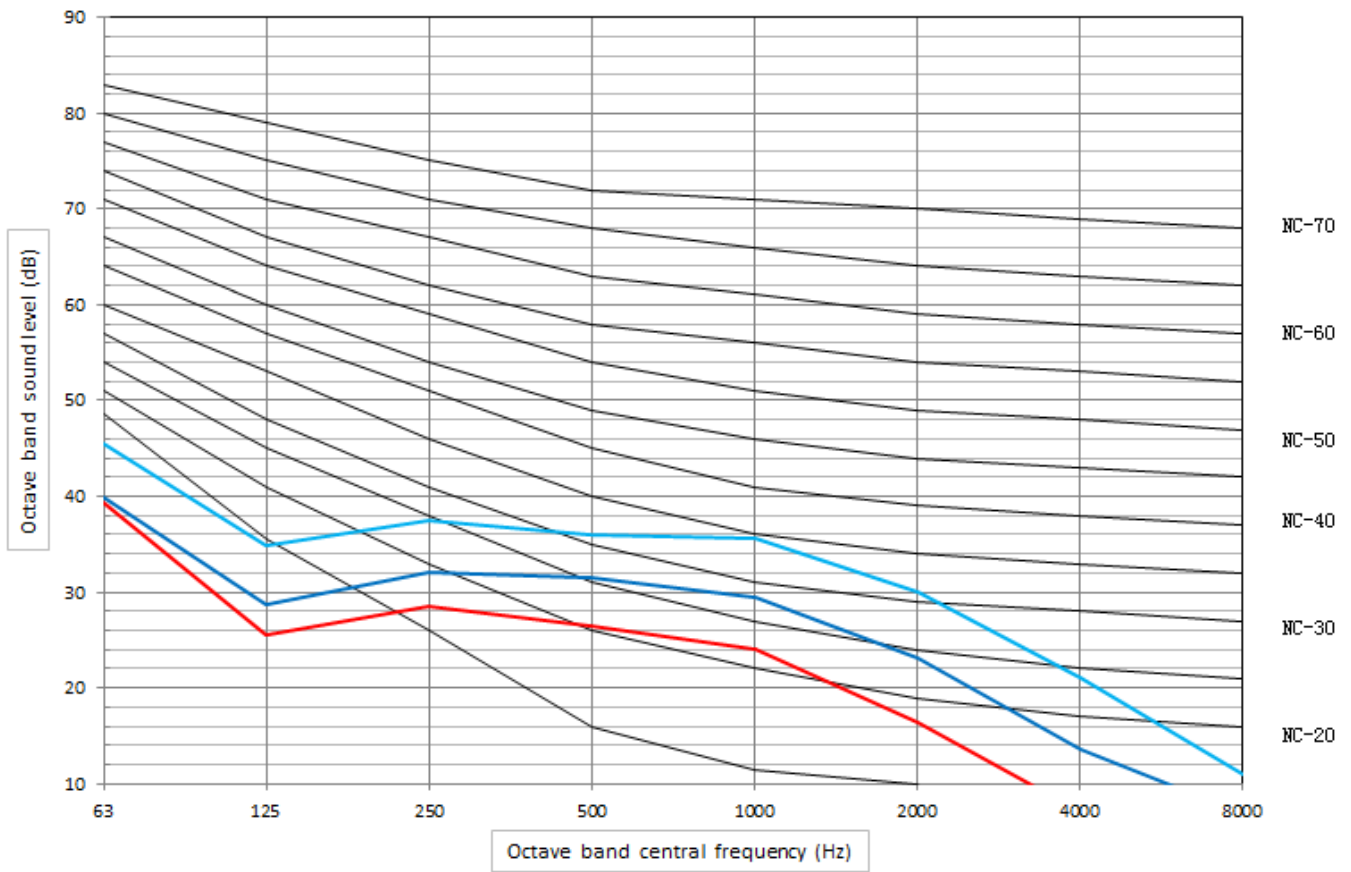

MKG-600BA

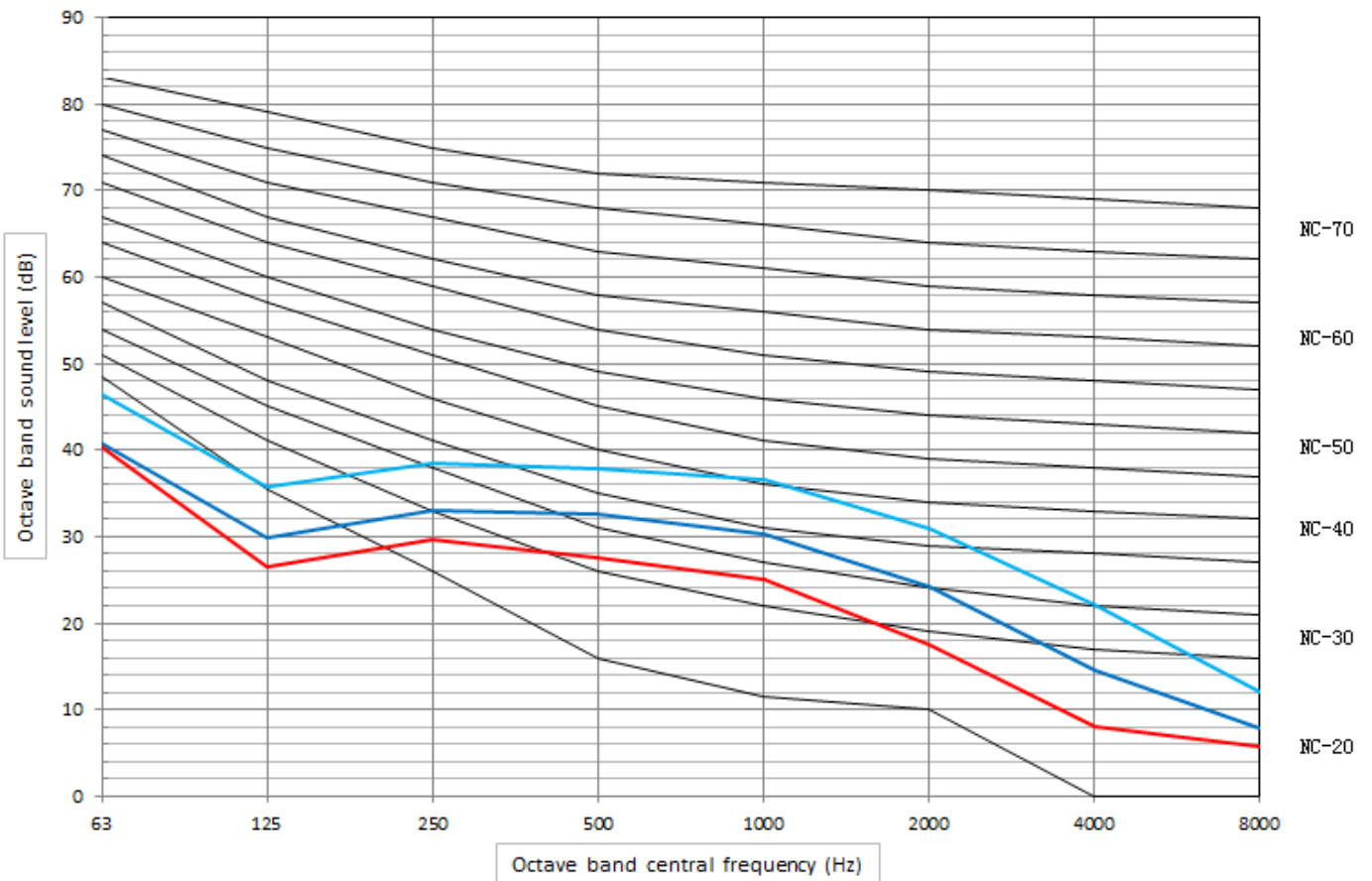

8. Exploded View

C panel

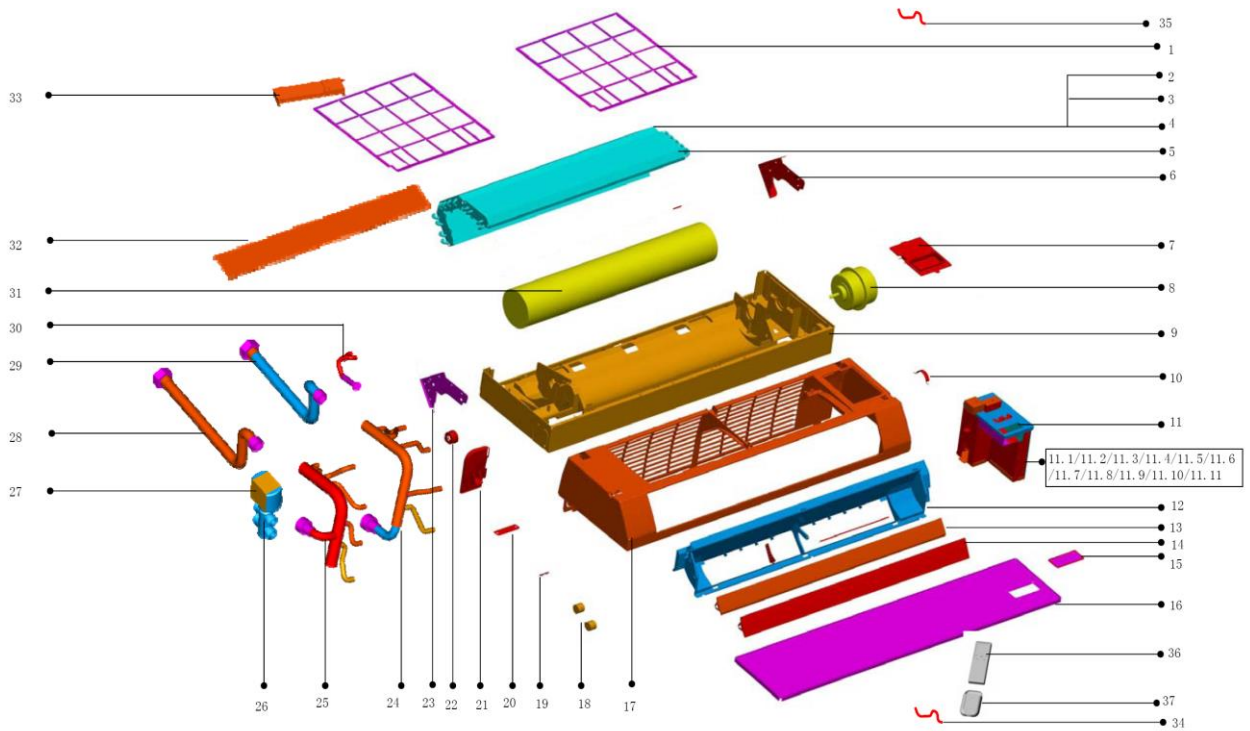

No.	Part Name	Quantity	No.	Part Name	Quantity
1	Filter	2	14	Louver	1
2	Evaporator I	1	15	Panel dalle	1
3	Evaporator II	1	16	Panel	1
4	Evaporator III	1	17	Panel frame ass'y	1

5	Coil temp sensor	1	18	Stepper motor	2
6	Evaporate connect board	1	19	Screw cover	3
7	Display board ass'y	1	20	Pipe clamp	1
8	Motor	1	21	Drainage pan	1
9	Base pan assembly	1	22	Bearing base	1
10	Motor spud	2	23	Evaporator left clapboard	1
11	E-part box ass'y	1	24	Water inlet pipe ass'y	1
11.1	Dial code switch box cover	1	25	Water outlet pipe ass'y	1
11.2	Electric control box seat	1	26	Three-way valve	1
11.3	E-Part box cover	1	27	Control wire for 3-Ways valve	1
11.4	Electric control box soleplate	1	28	Outlet screw pipe ass'y	1
11.5	Electric control box side board ass'y	1	29	Inlet screw pipe ass'y	1
11.6	Dial code switch board ass'y	1	30	Discharge valve	1
11.7	Main controller ass'y	1	31	Cross fan	1
11.8	Transformer	1	32	Base pan holder	1
11.9	Wire joint	1	33	Formaldehyde killer	1
11.10	Wire joint, 3p	1	34	Room Temperature Sensor Ass'y	1
11.11	Motor capacitor	1	35	Network matching wire	1
12	Air outlet frame mount ass'y	1	36	Remote controller	1
13	Louver board	1	37	Remote controller holder ass'y	1

S panel

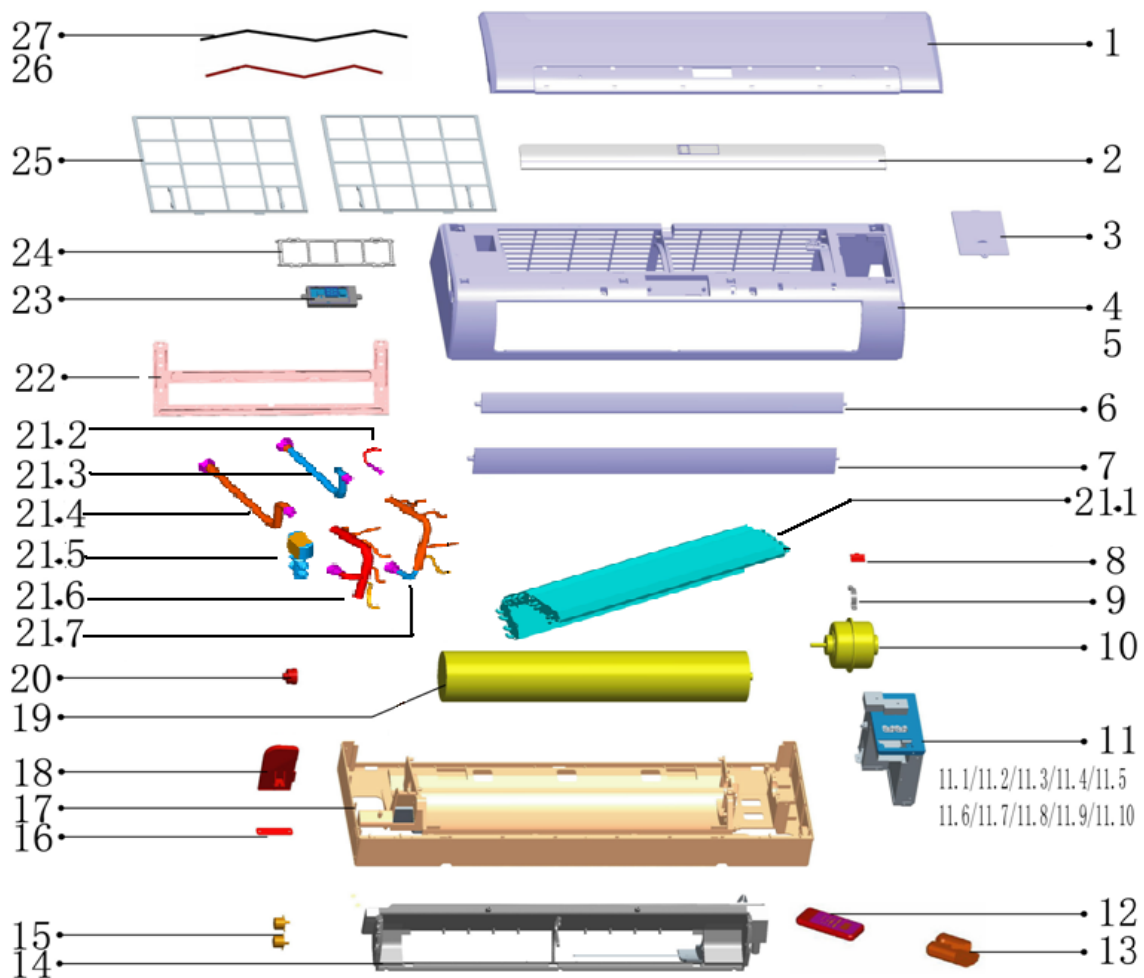

No.	Part Name	Quantity	No.	Part Name	Quantity
1	Panel ass'y	1	16	Pipe clamp	1
2	Panel decorative plates	1	17	Chassis ass'y	1
3	Electrical cover	1	18	Drainage pan ass'y	1
4	Panel frame ass'y	1	19	Cross fan	1
5	Screw cover	3	20	Bearing block	1
8	Sealing plug	2	21	Evaporator ass'y	1
9	Motor spud	2	21.1	Evaporator	1
10	Motor	1	21.2	Evaporator	1
11	E-part box ass'y	1	21.3	Evaporator	1
11.1	Electric control box base	1	21.4	Evaporate connecting board	1
11.2	Electric control box side panel	1	21.5	Evaporate connecting board	1
11.3	electric control box cover	1	21.8	Water-outlet pipe ass'y	1
11.4	Dial switch cover label	1	21.9	Water-inlet pipe ass'y	1
11.5	Dial code switch board ass'y	1	21.10	3-Way valve	1
11.7	Terminal block, 5p	1	21.11	Discharge valve	1
11.8	Main control board ass'y	1	22	Installation board ass'y	1
11.9	Terminal block, 3p	1	23	Display board ass'y	1
11.10	Capacitor	1	24	Air purify net	1
12	Remote controller	1	25	Filter network	2
13	Remote controller bracket	1	26	Pipe temp. sensor ass'y	1
14	Air outlet frame	1	27	Room temp sensor ass'y	1
15	Stepper motor	1			

13. Installation

13.1 Installation Attention

※ Warning:

- **Be sure only trained and qualified service personnel to install, repair or service the equipment.**
Improper installation, repair, and maintenance may result in electric shocks, short-circuit, leaks, fire or other damage to the equipment.
- **Install according to this installation instructions strictly.**
- **If installation is defective, it will cause water leakage, electrical shock and fire.**
- **When installing the unit in a small room, take measures against to keep water concentration from exceeding allowable safety limits in the event of water leakage.**
Contact the place of purchase for more information.
- **Use the attached accessories parts and specified parts for installation.**
Otherwise, it will cause the set to fall, water leakage, electrical shock fire.
- **Install at a strong and firm location which is able to withstand the set's weight.**
If the strength is not enough or installation is not properly done, the set will drop to cause injury.
- **The appliance must be installed 2.3m above floor.**
- **The appliance shall not be installed in the laundry.**
- **Before obtaining access to terminals, all supply circuits must be disconnected.**
- **The appliance must be positioned so that the plug is accessible.**
- **The enclosure of the appliance shall be marked by word, or by symbols, with the direction of the fluid flow.**
- **For electrical work, follow the local national wiring standard, regulation and this installation instruction. An independent circuit and single outlet must be used.**
If electrical circuit capacity is not enough or defect in electrical work, it will cause electrical shock fire.
- **Use the specified cable and connect tightly and clamp the cable so that no external force will be acted on**

the terminal.

If connection or fixing is not perfect, it will cause heat-up or fire at the connection.

- **Wiring routing must be properly arranged so that control board cover is fixed properly.**
- **If control board cover is not fixed perfectly, it will cause heat-up at connection point of terminal, fire or electrical shock.**

If the supply cord is damaged, it must be replaced by the manufacture or its service agent or a similarly qualified person in order to avoid a hazard.

- **An all-pole disconnection switch having a contact separation of at least 3mm in all poles should be connected in fixed wiring.**
- **Do not modify the length of the power supply cord or use of extension cord, and do not share the single outlet with other electrical appliances.**

Otherwise, it will cause fire or electrical shock.

- **Carry out the specified installation work after taking into account strong winds, typhoons or earthquakes.**
Improper installation work may result in the equipment falling and causing accidents.
- **If the water leaks during installation, ventilate the area immediately.**
- **After completing the installation work, check that water does not leak.**

※ Caution:

- **Ground the air conditioner.**

Do not connect the ground wire to gas or water pipes, lightning rod or a telephone ground wire. Incomplete grounding may result in electric shocks.

- **Be sure to install an earth leakage breaker.**

Failure to install an earth leakage breaker may result in electric shocks.

- **Connect the outdoor unit wires, then connect the indoor unit wires.**

You are not allowed to connect the air conditioner with the power source until wiring and piping the air conditioner is done.

- **While following the instructions in this installation manual, install drain piping in order to ensure proper drainage and insulate piping in order to prevent condensation.**

Improper drain piping may result in water leakage and property damage.

- **Install the indoor and outdoor units, power supply wiring and connecting wires at least 1 meter away from televisions or radios in order to prevent image interference or noise.**

Depending on the radio waves, a distance of 1 meter may not be sufficient enough to eliminate the noise.

- **The appliance is not intended for use by young children or infirm persons without supervision.**

- **Don't install the air conditioner in the following locations:**











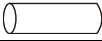

- There is petrolatum existing.
- There is salty air surrounding (near the coast).
- There is caustic gas (the sulfide, for example) existing in the air (near a hot spring).
- The Volt vibrates violently (in the factories).
- In buses or cabinets.
- In kitchen where it is full of oil gas.
- There is strong electromagnetic wave existing.
- There are inflammable materials or gas.
- There is acid or alkaline liquid evaporating.
- Other special conditions.

※ Installation Order:

- Select the location;
- Install the indoor unit;
- Install the outdoor unit;
- Connect the drain pipe;

- Wiring;
- Test operation.



13.2 Accessory

Name	Shape	Quantity	Function
Installation board		2	_____
Screw ST3.9x25 for installation board		3	Secure the installation board
Plastic expanded tube		3	_____
Wrapping tape		1	_____
Drain pipe		2	_____
Sealing clay		2	_____
Wall conduit cover		1	_____
Remote controller (including operation manual)		1	_____
Frame		1	Hold the remote controller
Mounting screw(ST2.9x10-C-H)		2	Insulation Holder for remote controller
Alkaline dry batteries (AM4)		2	_____
Owner's manual	_____	1	_____
Installation manual	_____	1	_____
12. seel gasket		4	For connecting water pipe

13.3 Inspecting and Handling the unit

At delivery, the package should be checked and any damage should be reported immediately to the carrier claims agent.

When handling the unit, take into account the following:

-  Fragile, handle the unit with care.
-  Keep the unit upright in order to avoid compressor damage.
- Choose on beforehand the path along which the unit is to be brought in.
- Move this unit as originally package as possible.
- When lifting the unit, always use protectors to prevent belt damage and pay attention to the position of the unit's centre of gravity.

13.4 Indoor Unit Installation

13.4.1 Installation place

Installation in the following places may cause trouble. If it is unavoidable, please consult with the local dealer.

- A place full of machine oil.
- A saline place such as coast.
- A place full of sulfide gas such as hot-spring resort.
- Places where there are high frequency machines such as wireless equipment, welding
- Machine and medical facility.
- A place there is no combustive gases and volatile matter.
- A place of special environmental conditions.

Installation in the following places:

- ✓ A place where is no obstacle near the inlet and outlet area.
- ✓ A place which can bear the indoor unit.

- ✓ A place which is convenient to maintenance.
- ✓ A place which provides the space around the indoor unit as required right in the diagram.
- ✓ There is strong electromagnetic wave existing.
- ✓ A place which is far from heat, steam and inflammable gas.

13.4.2 Drilling A Hole and Mounting Installation Board

Installation Board and Its Direction (unit: mm)

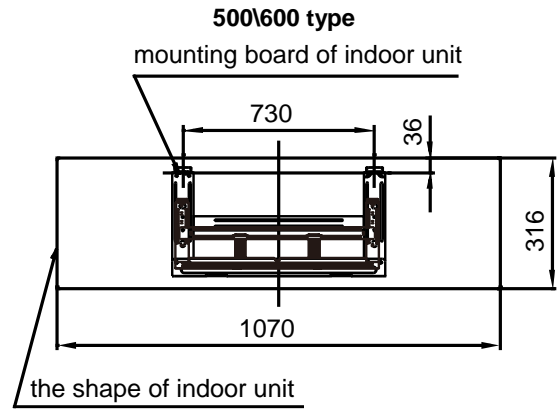
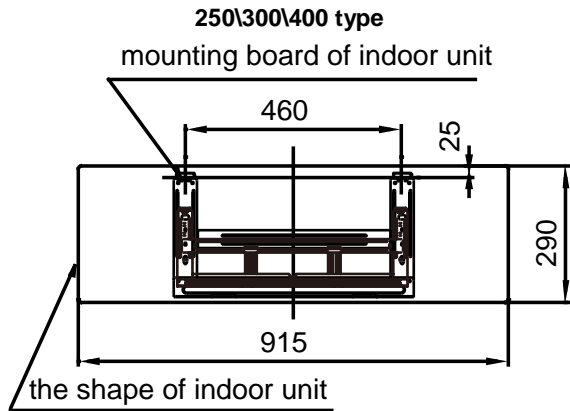

■ **Fix the installation board**

- Install the installation board horizontally on structural parts on the wall with the spaces provided around the plate.
- In case of brick, concrete or similar type walls, make 5mm dia. holes on the wall. Insert clip anchors for appropriate mounting screws.
- Fix the installation board on the wall.

Right installation

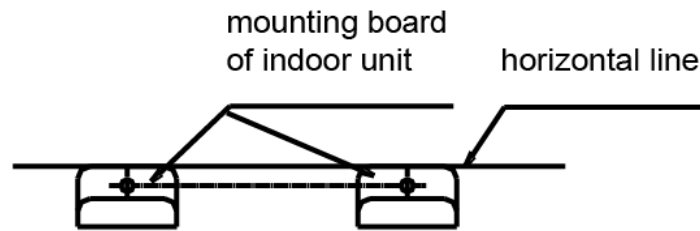

False installation

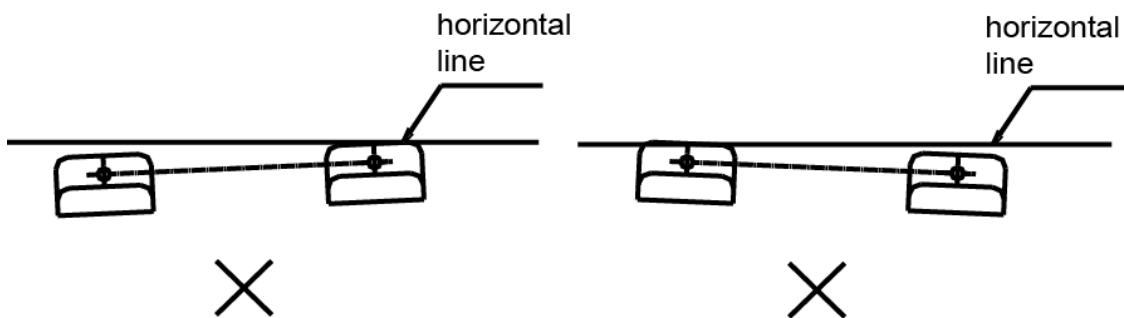

■ **Drilling a hole**

- Determine the pipe hole position using the installation board, and drill the pipe hole (N95mm) so it slants slightly downward.
- Always use a wall hole conduit when piercing metal lath, ply wood or metal plate.

13.4.3 Connective Pipe and Drainage Installation

■ **Drainage**

Run the drain hose sloping downward. Do not install the drain hose as illustrated below.

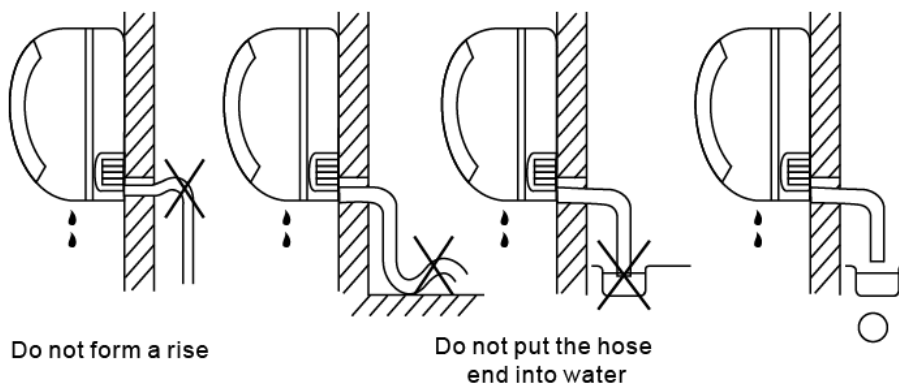

When connection extension drain hose, insulate the connecting part of extension drain hose with a shield pipe.

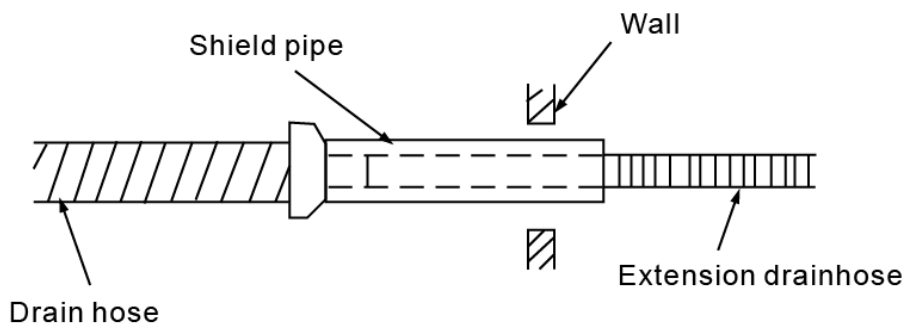

■ Connection pipe

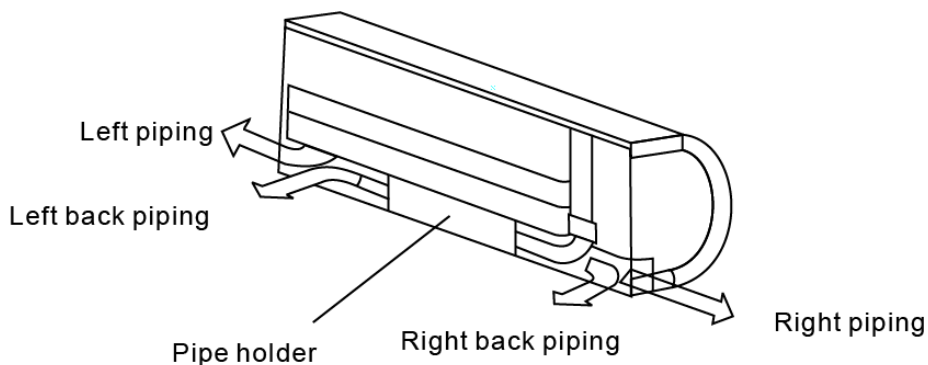

1. When install the water pipe of G unit, please following it

- a) Put down two screws between the pipe holder and unit, and then get down pipe holder. (Refer to the following fig)

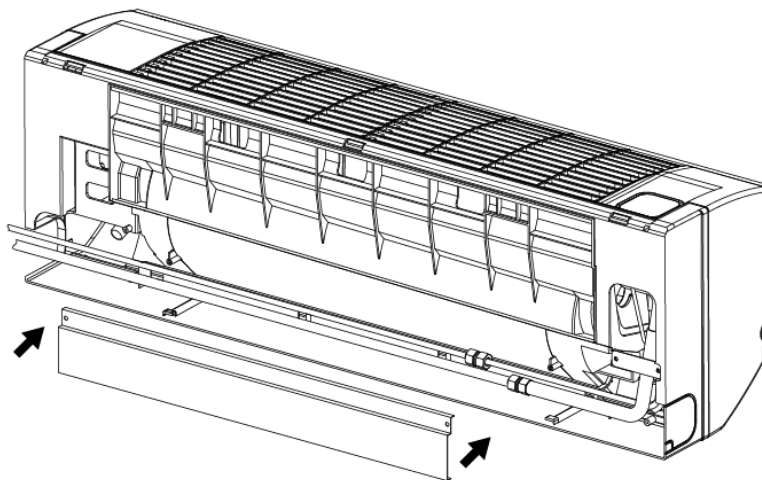

- b) Connect pipe.
- c) Install the pipe holder. (Refer to the following fig)

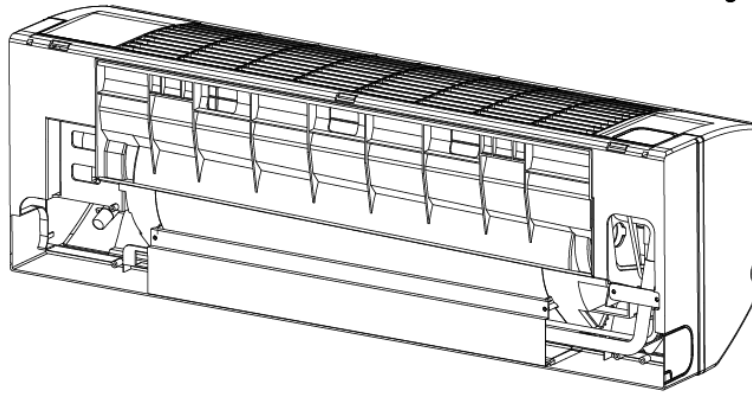

2. For the left-hand and rear-left-hand piping, install the piping as shown. Bend the connective pipe to be laid at 43mm height or less from the wall.

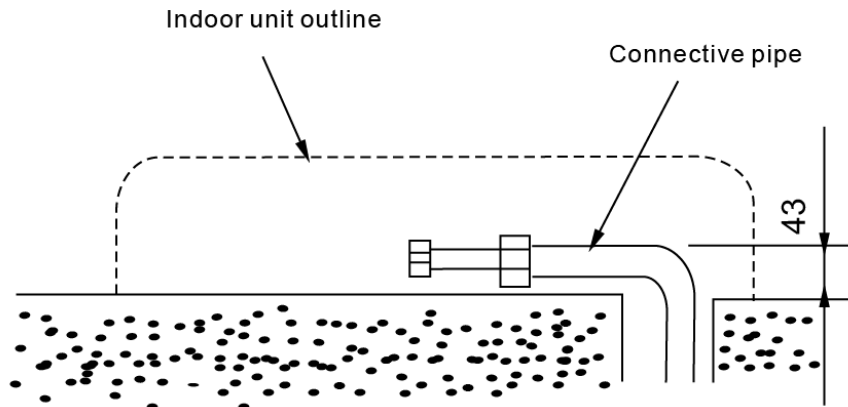

3. Fix the end of the connective pipe.

Caution:

- Connect the indoor unit first then the outdoor unit and bend and arrange the pipe carefully.
- Do not allow the piping to let out from the back of the indoor unit.
- Be careful not to let the drain hose slack.
- Insulate both of the auxiliary piping.
- Banding the drain hose under the auxiliary pipe.
- Do not allow the piping to let out from the back of the indoor unit.

■ Piping and bandaging

Wind the connective cable, drain hose and wiring with tape securely, evenly as shown below.

Because the condensed water from rear of the indoor unit is gathered in Pond Box and is piped out of room. Do not put anything else in the box.

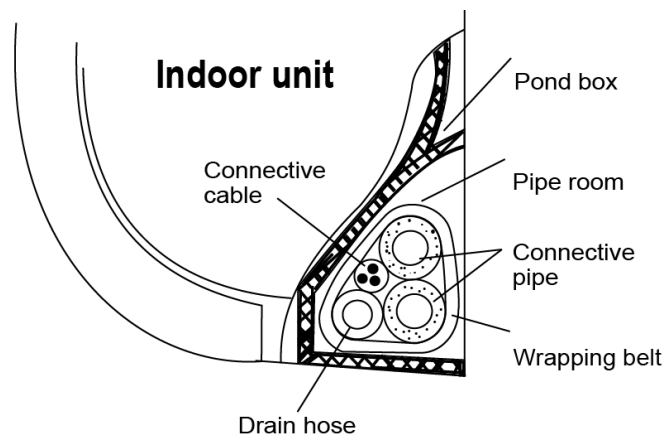

13.4.4 Indoor Unit Installation

- Pass the piping through the hole in the wall.
- Put the claw at the back of the indoor unit on the hook of the installation board, move the Indoor Unit from side

to side to see that it is securely hooked.

- Piping can easily be made by lifting the indoor unit with a cushioning material between the indoor unit and the wall. Get it out after finish piping.
- Push the lower part of the Indoor Unit up to the wall, then move the Indoor Unit from side to side, up and down to check if it is hooked securely.

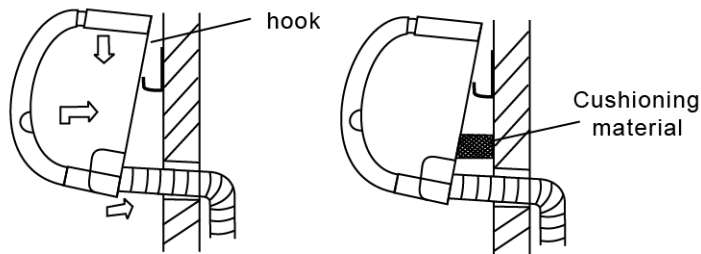

13.5 Water Pipe Installation

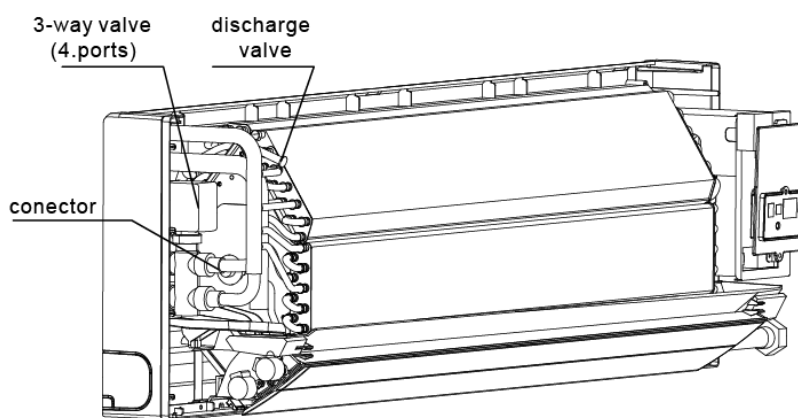

Material and Size of the Piping

Pipe material	Copper Pipe for Air Conditioner	
Model	250/300/400	500/600
Coil connections (flat plate)	3/4"	3/4"
	3/4"	3/4"

Connection of the water pipe should be done by professionals. Double-span should be used when connecting pipes of Indoor Unit.

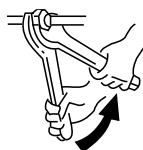

At the first debugging, completely expel air from coils via expelling valve.

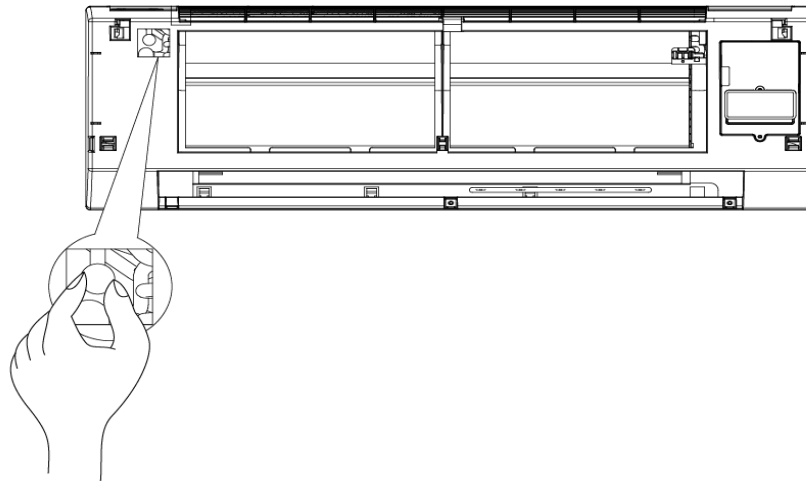

13.6 Wiring

Cautions:

- The reserved function is indicated in broken line table, users can select it when necessary.
- An all-pole disconnection device which has at least 3mm separation distance in all pole and a residual current device (RCD) with the rating of above 10mA shall be incorporated in the fixed wiring according to the national rule.
- The appliance shall be installed in accordance with national wiring regulations.

Take out the faceplate, and then dismantle the display cover.

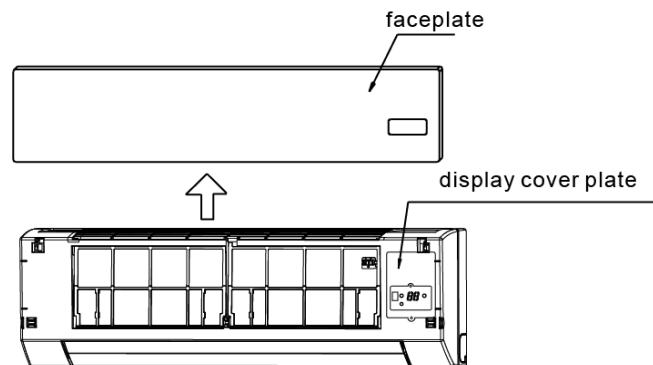

Individual connect the power cord and signal line, adjust the dial switch.

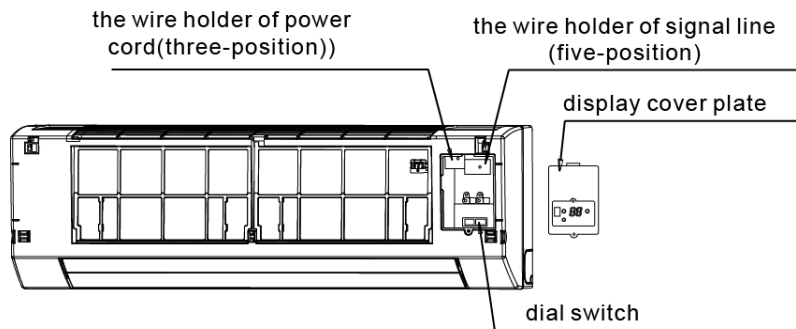

13.6.1 Terminal Board Diagram

The wiring diagram please refers to chapter 9.

Note:

The air-conditioners can connect with Central Control Monitor (CCM). Before operation, please wiring correctly and set system address and network address of indoor units.

Single phase indoor unit:

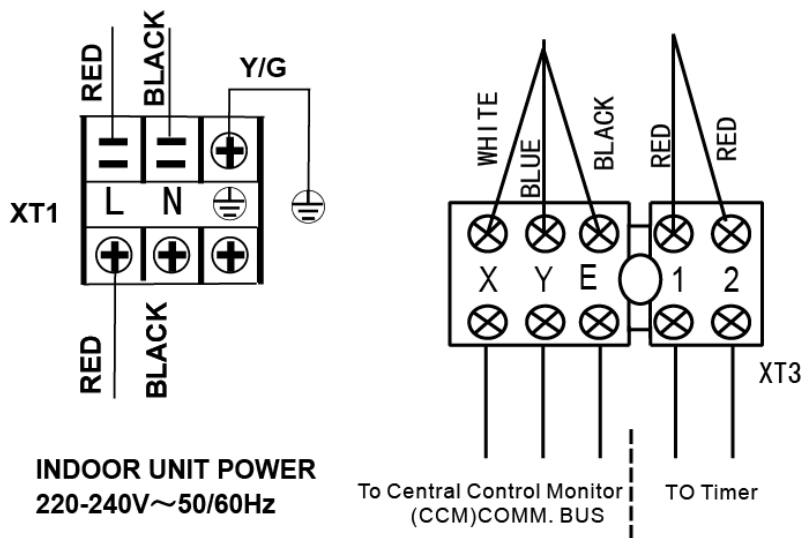

Please adopt the shielded twisted-pair wire, and connect the shielded layer to E

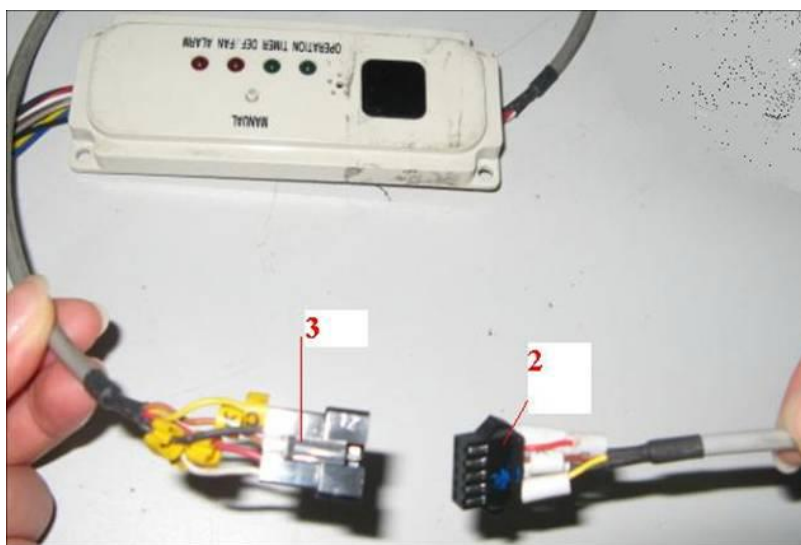
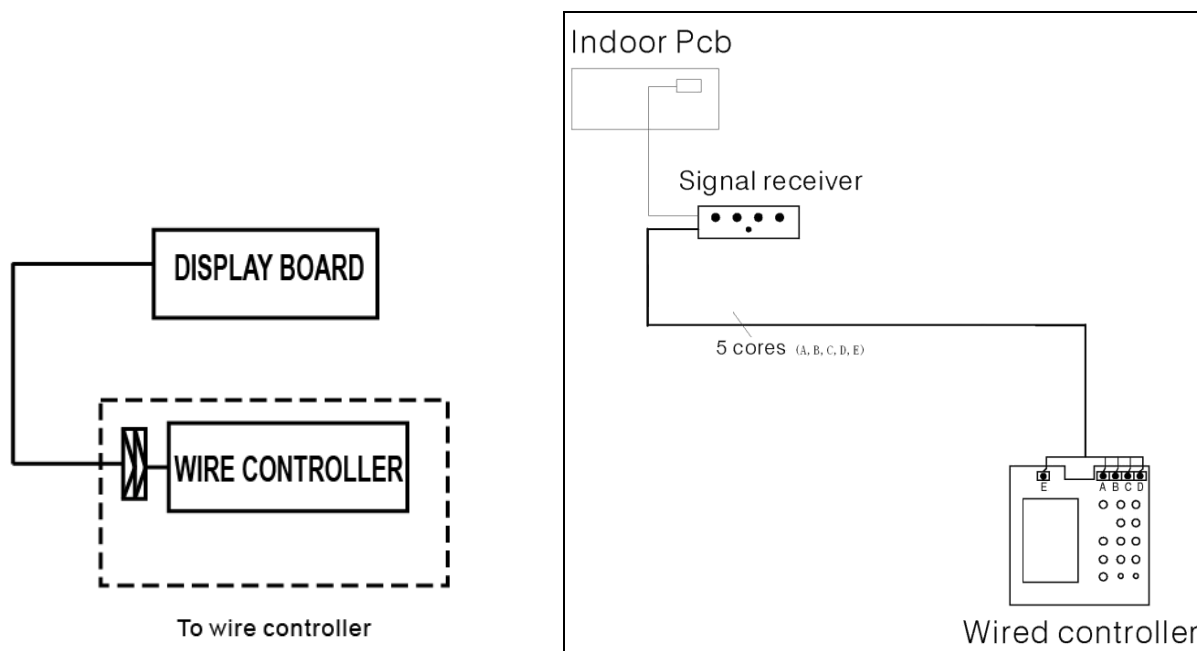





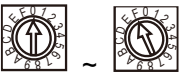

Insert 2 & 3 together is OK

The reserved wire control function is indicated in broken line table, users can purchase the wire controller when necessary.

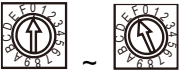
13.6.2 Network address set

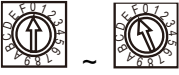
Every air-conditioner in network has only one network address to distinguish each other. Address code of air-conditioner in LAN is set by code switch on Network Interface Module (NIM), and the set range is 0-63.

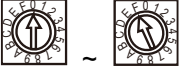
Toggle switch set		Network address code
SW1	ENC2	
		00~15
		16~31
		32~47
		48~63

13.7 Trouble-shooting

Malfunction code	Malfunction
EE	Water-level alarm malfunction
E3	T2 evaporator sensor malfunction
E2	T1 evaporator sensor malfunction
E8	Fan motor malfunction
E7	EEPROM communication error

13.7.1 EE: Water-level alarm malfunction

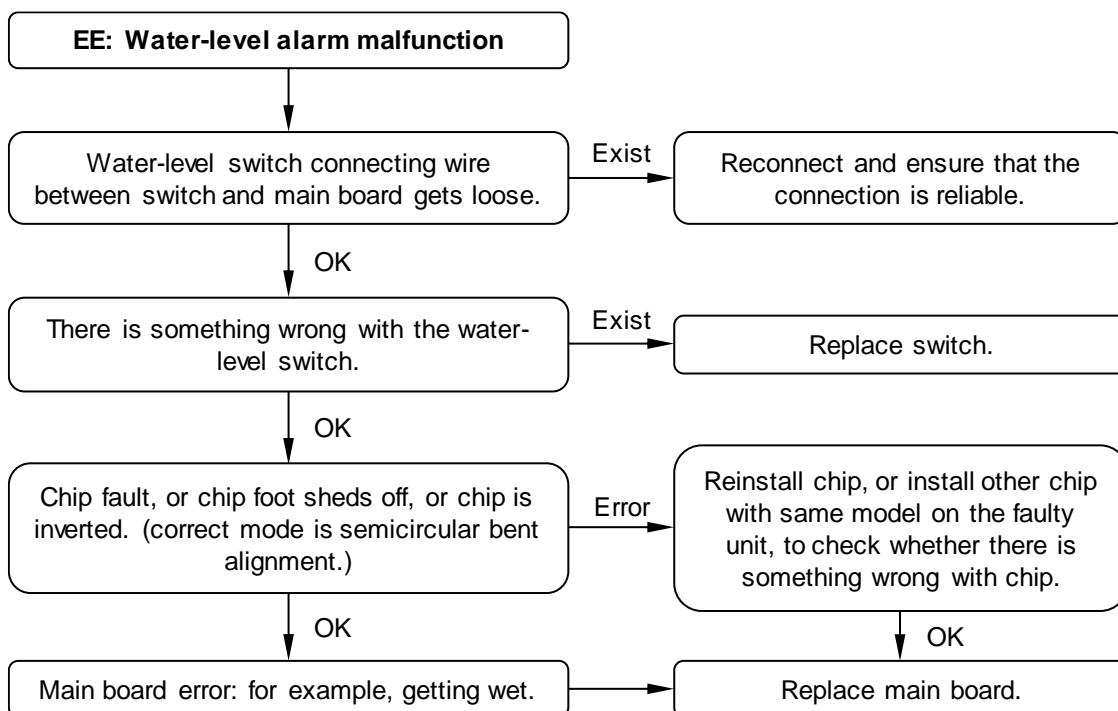

13.7.2 E2: T1 evaporator sensor malfunction

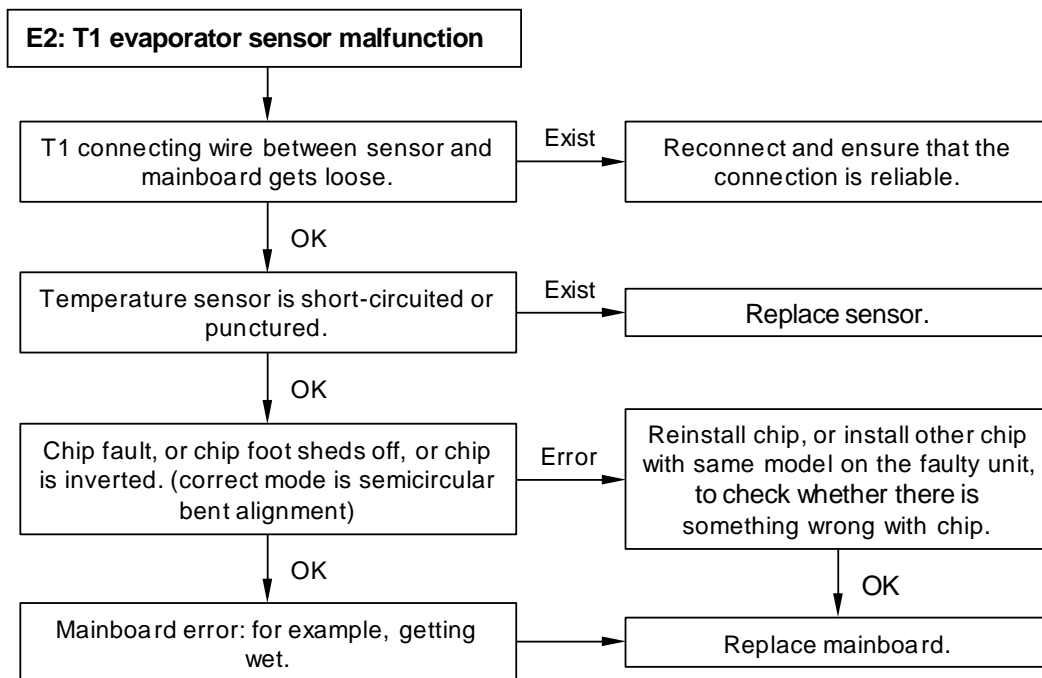

13.7.3 E3: T2 evaporator sensor malfunction

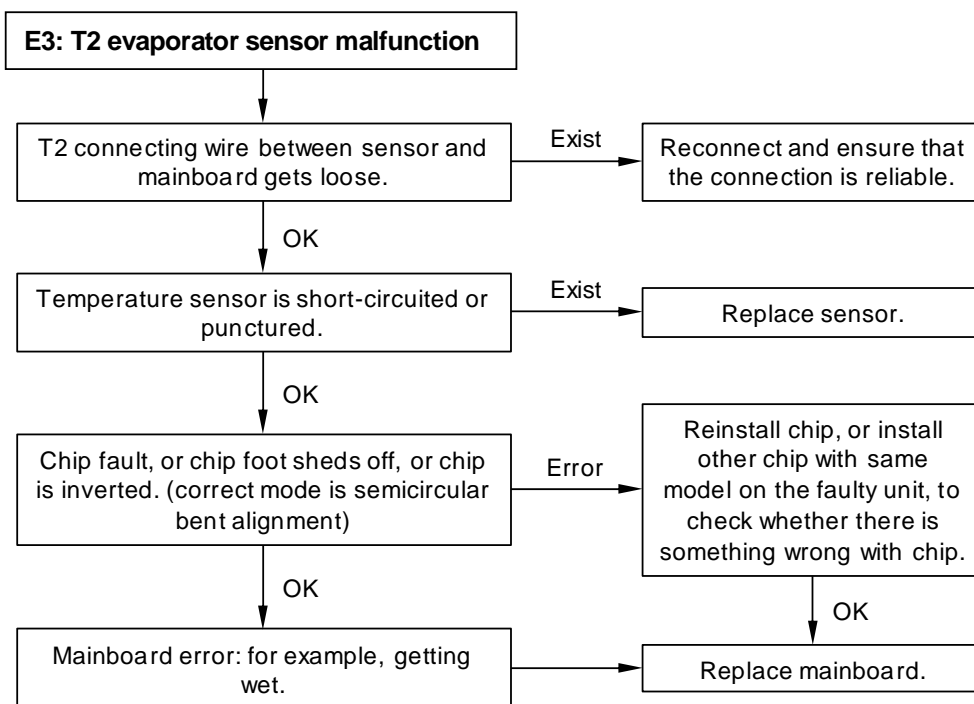

13.7.4 E8: Fan motor malfunction

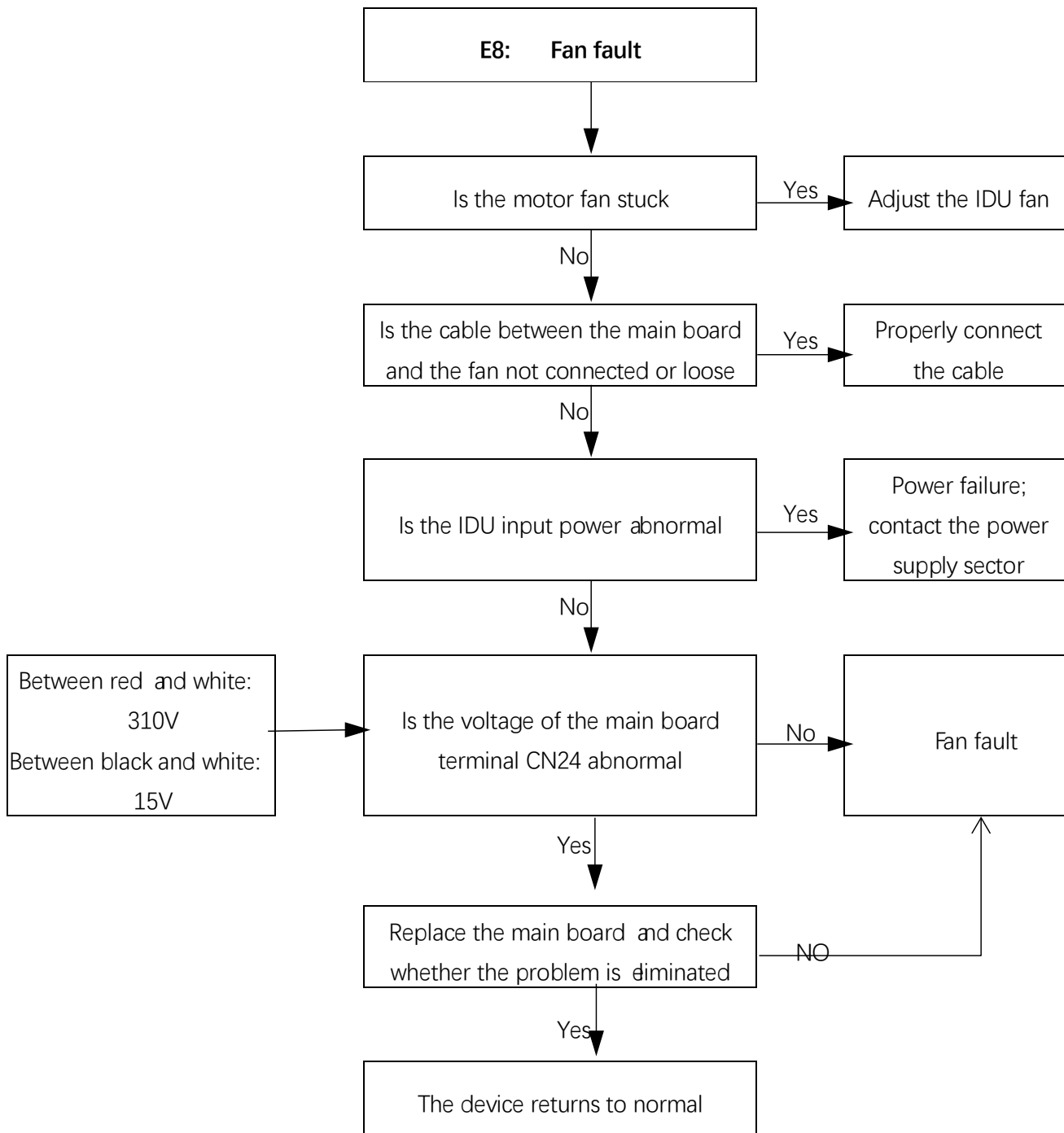

13.7.5 EEPROM communication error

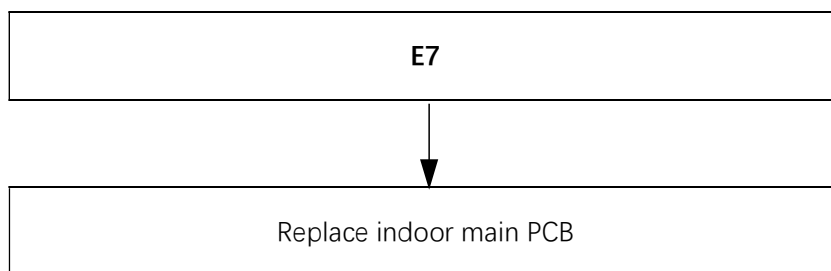

13.7.1 Troubles and causes of air conditioner

If one of the following malfunctions occur, stop operation, shut off the power, and contact with your dealer.

- The operation lamp is flashing rapidly (twice every second)
- This lamp is still flashing rapidly after turn off the power and turn on again.
- Remote controller receives malfunction or the button does not work well.
- A safety device such as a fuse, a breaker frequently actuates.
- Water leaks from indoor unit.
- Other malfunctions.

Symptoms	Causes	Solution
Unit does not start	<ul style="list-style-type: none"> • Power failure; • Power switch is off; • Fuse of power switch may have burned; • Batteries of remote controller exhausted or other problem of controller. 	<ul style="list-style-type: none"> • Wait for the comeback of power; • Switch on the power; • Replace the fuse; • Replace the batteries or check the controller.
Air flowing normally but completely can't cooling	<ul style="list-style-type: none"> • Temperature is not set correctly. 	<ul style="list-style-type: none"> • Set the temperature properly.
Low cooling effect	<ul style="list-style-type: none"> • Indoor unit heat exchanger is dirty; • The air filter is dirty; • Inlet of indoor unit is blocked; • Doors and windows are open; • Sunlight shine directly; • Too many heat resources; • Outdoor temperature is too high. 	<ul style="list-style-type: none"> • Clean the heat exchanger; • Clean the air filter; • Eliminate all dirties and make air smooth; • Close doors and windows; • Make curtains in order to shelter from sunshine; • Reduce heat resource; • AC cooling capacity reduces (normal).
Low heating effect	<ul style="list-style-type: none"> • Outdoor temperature is lower than 7°C; • Doors and windows are not completely closed. 	<ul style="list-style-type: none"> • Use heating device; • Close doors and windows.

13.7.2 Troubles and causes of remote controller

Before asking for serving or repairing, check the following points.

Symptoms	Causes	Solution
The fan speed can not be changed.	<ul style="list-style-type: none"> • Check whether the MODE indicated on the display is "AUTO". 	When the automatic mode is selected, the air conditioner will automatically change the fan speed.
	<ul style="list-style-type: none"> • Protection against hot wind in cooling mode. • Protection against cold wind in heating mode. 	Reduce the temperature of inlet in cooling mode rise the temperature of inlet in heating mode.
The remote controller signal is not transmitted even when the ON/OFF button is pushed.	<ul style="list-style-type: none"> • Check whether the batteries in the remote controller are exhausted. 	The power supply is off.
The TEMP. indicator does not come on.	<ul style="list-style-type: none"> • Check whether the MODE indicated on the display is "FAN ONLY". 	The temperature cannot be set during FAN mode.
The indication on the display disappears after a lapse of time.	<ul style="list-style-type: none"> • Check whether the timer operation has come to an end when the "TIMER OFF" is indicated on the display. 	The air conditioner operation will stop up to the set time.

The TIMER ON indicator goes off after a lapse of certain time.	<ul style="list-style-type: none"> • Check whether the timer operation is started when the "TIME ON" is indicated on the display. 	Up to the set time, the air conditioner will automatically start and the appropriate indicator will go off.
No receiving tone sounds from the indoor unit even when the ON/OFF button is pressed.	<ul style="list-style-type: none"> • Check whether the signal transmitter of the remote controller is properly directed to the infrared signal receiver of the indoor unit when the ON/OFF button is pressed. 	Directly transmit the signal transmitter of the remote controller to the infrared signal receiver of the indoor unit, and then repeatedly push the ON/OFF button twice.

14. Controller

14.1 Wireless remote controller R51/E

■ Remote Controller Specifications

Model	R51/E
Rated Voltage	3.0V
Lowest Voltage of CPU Emitting Signal	2.0V
Reaching Distance	8m (when using 3.0 voltage, it can get 11m)
Environment Temperature Range	-5°C ~ 60°C

■ Introduction of Function Buttons on the Remote Controller

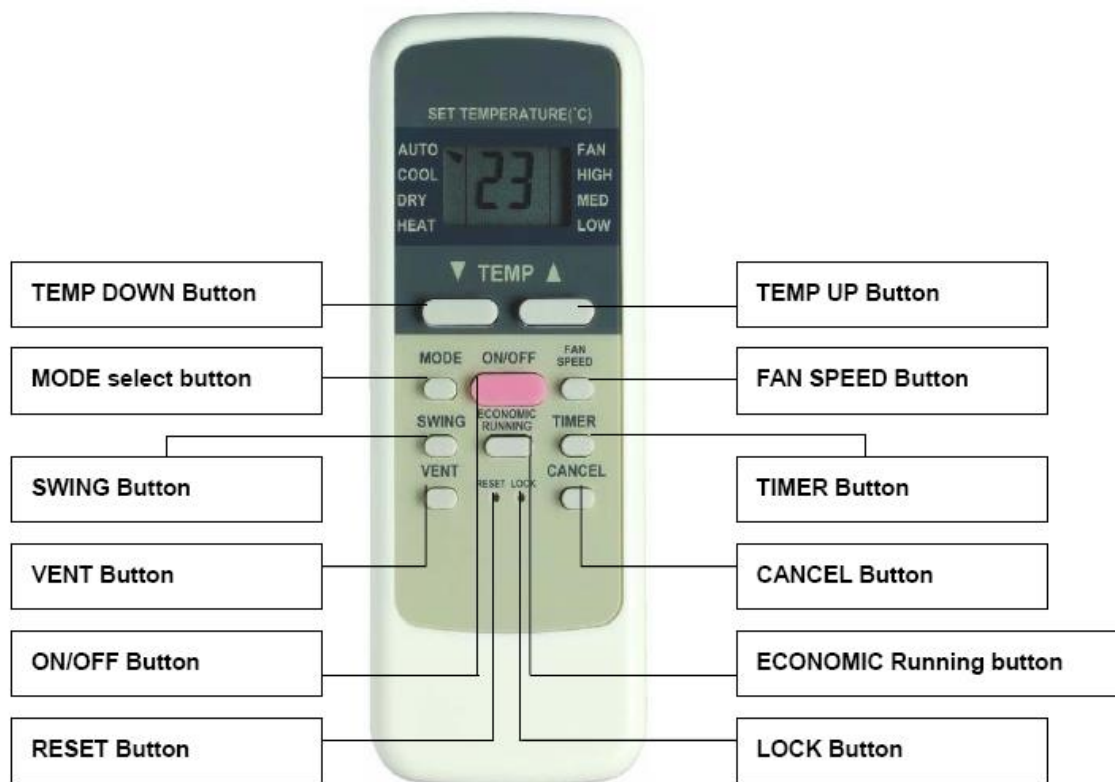

1. **TEMP DOWN Button:** Push the TEMP DOWN button to decrease the indoor temperature setting or to adjust the timer in a counter-clockwise direction.
2. **MODLE SELECT Button:** Each time you push the button, a mode is selected in a sequence that goes from AUTO, COOL, DRY, HEAT and FAN as the following figure indicates:



Note: HEAT only for Heat Pump.

3. **SWING Button:** Push this switch button to change the louver angle.
4. **RESET Button:** When the RESET button is pushed, all of the current settings are cancelled and the control will return to the initial settings.
5. **ECONOMIC RUNNING Button:** Push this button to go into the Energy-Saving operation mode.
6. **LOCK Button:** Push this button to lock in all the current settings. To release settings, push again.
7. **CANCEL Button:** Push this button to cancel the TIMER settings.
8. **TIMER Button:** This button is used to preset the time ON (start to operate) and the time OFF (turn off the operation)
9. **ON/OFF Button:** Push this button to start the unit operation. Push the button again to stop the unit operation.
10. **FAN SPEED Button:** This button is used for setting fan speed in the sequence that goes from AUTO, LOW, MED to HIGH, and then back to Auto.
11. **TEMP UP Button:** Push this button to increase the indoor temperature setting or to adjust the timer in a counter-clockwise direction.
12. **VENT Button:** Push this button to set the ventilating mode. The ventilating mode will operate in the following sequence:

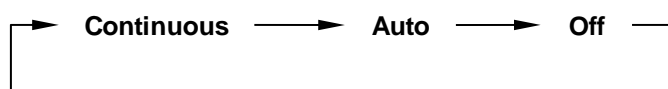

Note: Ventilation Function is available for the Fresh Star Series.

■ Introduction of Indicators

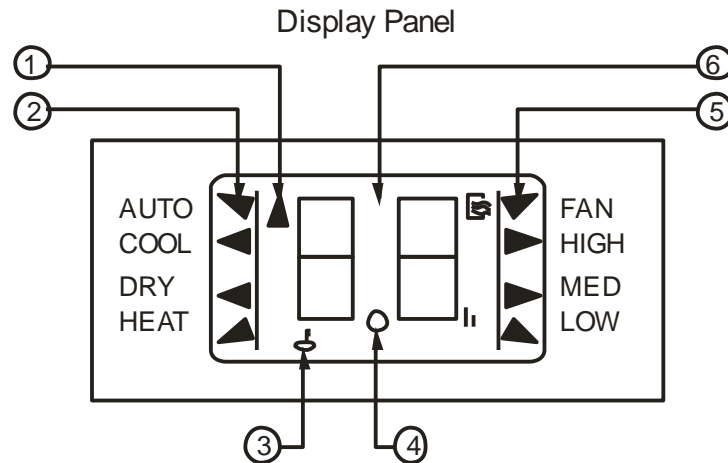

1. **TRANSMISSION Indicator:** This indicator lights when remote controller transmits signals to indoor unit.
2. **MODE Display:** Shows the current operation mode - AUTO, COOL, DRY or HEAT. HEAT only available for heat pump model.
3. **HEAT PUMP ONLY- LOCK display** is displayed by pushing the LOCK button. Push the LOCK button again to clear display.
4. **TIMER Display:** This display area shows the settings of TIMER. That is, if only the starting time of operation is set, it will display the TIMER ON. If only the turning off time of operation is set, it will display the TIMER OFF. If both operations are set, it will show TIMER ON OFF which indicates you have chosen to set both the starting time and off time.
5. **FAN Display:** When the FAN button is pushed, this signal indicator lights.
6. **Digital Display Area:** This area will show the temperature, and if in the TIMER mode, it will show the ON and OFF settings of the TIMER.

Note: All items are shown in the Fig for the purpose of clear presentation, But during the actual operation only the relative functional items are shown on the display panel.

■ Operational Guidelines

Operating the Remote Controller

- **Install / Replace Batteries:** The Remote Controller uses two alkaline dry batteries(R03/Ir03×2).
 1. To install batteries, slide back the cover of the battery compartment and install the batteries according to the directions (+and -) shown on the Remote Controller.
 2. To replace the old batteries , use the same method as mentioned above.

Note:

1. When replacing batteries, do not use old batteries or a different type battery. This may cause the remote controller to malfunction.
2. If you do not use the remote controller for several weeks remove the batteries. Otherwise battery leakage may damage the remote controller.
3. The average battery life under normal use is about 6 months.
4. Replace the batteries when there is no answering beep from the indoor unit or if the Transmission Indicator light fails to appear.

Automatic Operation

- When the Air Conditioner is ready for use, switch on the power and the OPERATION indicator lamp on the display panel of the indoor unit starts flashing.
 1. Use the MODE select button to select AUTO.
 2. Push the TEMP button to set the desired room temperature. The most comfortable temperature settings are between 21°C to 28°C.

3. Push the ON/OFF button to start the air conditioner. The OPERATION lamp on the display panel of the indoor unit lights. The operating mode of AUTO FAN SPEED is automatically set and there are no indicators shown on the display panel of the remote controller.
4. Push the ON/OFF button again to stop the unit.

Notes:

1. In the AUTO mode, the air conditioner can logically choose the mode of COOL, FAN, HEAT and DRY by sensing the difference between the actual ambient room temperature and the set temperature on the remote controller..
2. If the AUTO mode is not comfortable for you , the desired mode can be selected manually.

COOL, HEAT, and FAN ONLY Operation

- If the AUTO mode is not comfortable, you may manually override the settings by using COOL, DRY, HEAT(HEAT PUMP units only), or FAN ONLY modes.
- Push the TEMP button to set the desired room temperature. When in COOLING mode, the most comfortable settings are 21°C or above. When in HEATING mode, the most comfortable settings are 28°C or below.
- Push the FAN SPEED to select the FAN mode of AUTO, HIGH, MED or LOW.
- Push the ON/OFF button. The operation lamp lights and the air conditioner starts to run according to your settings.
- Push the ON/OFF button again to stop.

Note:

The FAN ONLY mode cannot be used to control the temperature. While in this mode, only steps 1, 3 and 4 may be performed.

Dry Operation

1. Push the MODE button to select DRY.
2. Push the TEMP button to set the desired temperature from 21°C to 28°C.
3. Push the ON/OFF button. The operation lamp lights and the air conditioner starts to run in the DRY mode. 4. Push the ON/OFF button again to stop the unit.

Note:

Due to the difference of the set temperature of the unit and the actual indoor temperature, the Air Conditioner when in DRY mode will automatically operate many times without running the COOL and FAN mode.

Time Operation

PUSH TIMER button to set the on and off times of the unit.

1. To set the STARTING time.

- 1) Please push the CANCEL button to cancel any former settings.
- 2) Push the TIMER button. The remote controller will show the TIMER and the signal "h" is shown on the display panel. The control is now ready to reset the TIMER ON to start the operation.
- 3) Push the TEMP button (▼ or ▲) to set desired unit START time .
- 4) After setting the TIMER there will be a one-half second delay before the remote controller transmits the signal to the Air Conditioner. Then, after approximately another 2 seconds, the set temperature will re-appear on the digital display.

2. To set the STOPPING time.

- 1) Please press the CANCEL button to cancel any former settings.
- 2) Push the TIMER button and the remote controller will show the last set time for the START operation and the signal "h" will be shown on the display panel. You are now ready to re-adjust the TIMER OFF to stop the operation.
- 3) Push the TEMP button to cancel the TIMER ON setting. The digital area will show "00".
- 4) Push the TIMER button and the remote controller will show the last set time for the STOP operation and the signal "h" will be shown on the display panel. You are now ready to reset the time of the STOP operation.
- 5) Push the TEMP button (▼ or ▲) to set the time you want to stop the operation.

6) After setting the TIMER there will be a one-half second delay before the remote controller transmits the signals to the Air Conditioner. Then after approximately another 2 seconds, the set temperature will re-appear on the digital display.

3. Set the STARTING & STOPPING time

- 1) Please press the CANCEL button to cancel any former settings.
- 2) Push the TIMER button and the remote controller will show the last setting time for START operation and the signal "h" will be shown on the display panel. You are now ready to readjust the TIMER ON to start the operation.
- 3) Push the TEMP button (▼ or ▲) to set the time you want to start the operation.
- 4) Push the TIMER button and the remote controller will show the last set time for STOP operation and the signal "h" will be shown on the display panel. You are now ready to reset the time of the STOP operation.
- 5) Push the TEMP button (▼ or ▲) to set the time you want to stop the operation.
- 6) After setting the TIMER there will be a one-half second delay before the remote controller transmits the signal to the Air Conditioner. Then, after approximately another 2 seconds, the set temperature will re-appear on the digital display.

Notes:

1. Please reset the TIMER after cancelling the former time settings.
2. The setting time is relative time. That is the time set is based on the delay of the current time.

14.2 Optional Controller

14.2.1 Wired Controller KJR-29B



KJR-29B

Wired controller specifications

Model	KJR-29B/BK-E
Power Supply Voltage	DC 5.0 V
Ambient Temperature Range	-5°C~+43°C
Ambient Humidity Range	RH40%~RH90%

. Performance features

1. Operating mode: cool, heat, dry, fan and auto.
2. Set the mode through buttons.

- 3. Indoor setting temperature range: 17°C ~30°C.
- 4. LCD (Liquid Crystal Display).
- 5. Touch key
- 6. Can switch Fahrenheit degree and Centigrade degree.

14.2.2 Function summarize

KJR-29B is the touch key wired controller.

New function	Basic function
Air filter cleaning reminding function	ON and OFF the air-conditioner
Indoor unit address setting function	Auto-restart function
Remote control receiver function	Time ON and Time OFF setting
Lock the wired controller	Clock setting
Silent mode	Setting the Operating mode, Temperature
Follow me	Fan speed and Swing functions

Function summarize

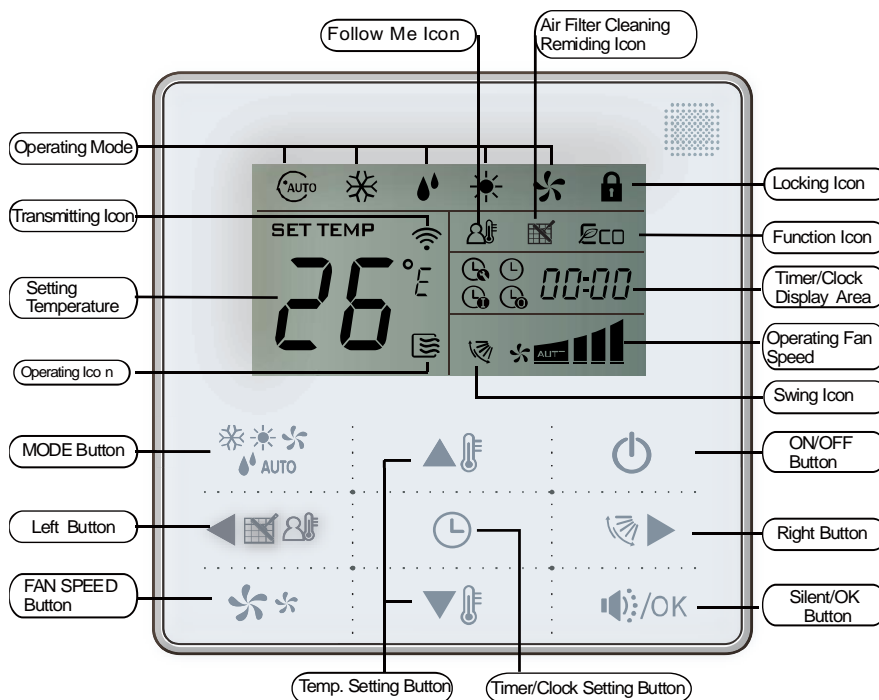

(1) Remote signal receiving function

There is the signal receiver for wireless remote controller on the KJR-29B. You can use the wireless remote controller to control the air-conditioner through the wired controller when the system has been powered on.

Notes: The wired controller will not receive the swing controlling instruction. For the indoor unit with swinging function, you can directly use the remote controller to control swinging through the display panel of the indoor

unit, or use the swing button on the wired remote controller to control the indoor unit for swinging.

(2) ON/OFF button

Press the ON/OFF button to control the indoor unit on and off state. When the unit is turned off, press the ON/OFF button, the unit will be turned on and the operating icon lights up. When the unit is turned on, press the ON/OFF button, the unit will be turned off and the operating icon lights off.

(3) Mode button

Press the mode button to set the operating mode, after each button press the operation mode will circle as follow:



When the controller has been set to cool-only, then there is no HEAT mode.

(4) Fan speed setting

Under COOL, HEAT and FAN modes, press the fan speed button can adjust the fan speed setting. After each fan speed button press will circle as follow:

AUTO → LOW → MID → HIGH → AUTO

Under AUTO and DRY modes, the fan speed is not adjustable and the default fan speed is auto.

(5) Temperature setting

Under AUTO, COOL, DRY, HEAT modes, press the Temp adjust Up/Down buttons to set the temperature, the adjusting range is 17°C~30°C (or 62°F~88°F). The setting temperature cannot be adjusted under FAN mode.

(6) Timer on and Timer off setting

Press the timer/clock setting button, then enter into the timer on setting state, and the screen will display timer

icon  and .

You can press Temperature setting buttons to adjust the time. When the time setting is less than 10 hours, each press the Temp setting buttons will increase or decrease 0.5 hour. When the timer setting is more than 10 hours, each press Temp setting buttons will increase or decrease 1 hour, the maximum timer setting is 24 hours. After finish adjusting the time on setting, press the Silent/OK button or wait for 5 seconds to confirm and exit the time on setting.

Notes: If the wired controller has been set timer on/ off, press the ON/OFF button to turn on/ turn off the unit

then the timer will be canceled simultaneously.

(7) Clock setting

Long press the timer/clock setting button for 3 seconds, and then enter into the clock setting state. The hour position of the clock will flash, and can press Temp setting buttons to adjust the hour value.

After finish the hour setting, press left button or right button to switch to minute position setting, then the minute position will flash, press Temp setting buttons to adjust the minute value. After finish the clock setting, press the button or wait for 5seconds to confirm and exit the setting state.

(8) Silent/OK button

Under the cooling, heating and auto mode, when operate the silent mode, it can reduce the running noise through setting the fan speed to low. This will help you bring a quieter environment.

Under AUTO, DRY mode, the fan speed is auto and the Silent /OK button doesn't work.

(9) Wired controller locking

Short press the temperature adjusting UP and DOWN buttons simultaneously, the wired controller enters into locking state, and the locking icon will be lighted up. Under the locking state, the wired controller will not respond to buttons by pressing and the control instruction from the wireless remote controller. Simultaneously press temperature adjusting buttons again will cancel the locking state.

(10) Air filter cleaning reminding function

The wired controller records the total running time of the indoor unit, when the accumulated running time reaches the pre-set value, air filter cleaning reminding icon will be lighted up, to remind that the air filter of the indoor unit needs to be cleaned. Long press left button for 3 seconds, and clear the reminding icon and the wired controller will re-accumulate the total running time of the indoor unit.

Notes: The default setting value of reminding function is 2500 hours, and it can change to be 1250 hours, 5000 hours or 10000 hours.

(11) Swing function

If the indoor unit supports swing function, press the right button to adjust the air outlet direction of the indoor unit. Long press this button for 3 seconds can turn on or turn off the auto-swing function. When the auto-swing function is turned on, the swing icon will be lighted up.

(12) Follow me function

When the system is running and the operating mode is Cooling, Heating or Auto, press the left button will activate the Follow Me function. Press left button again will cancel follow me function. When the operating mode is changed, and then will cancel this function as well. When the Follow Me function is activated, the icon will be light up, and the wired controller will display room temperature read from the local sensor, and transmit the temperature value to the indoor unit every 3 minutes.

(13) Setting addresses

- ✚ Press the Temp. UP and DOWN button simultaneously for more than 8 seconds, then the controller gets into address setting mode.
- ✚ In the address setting mode, there are 2 main functions:
 - Querying address: press MODE button, the corresponding indoor unit will display its address.
 - Setting address: use the UP and DOWN buttons to choose an address you want. Then press the FAN button to set the indoor unit's address. The corresponding indoor unit will display the new address and record it. After about 4 seconds, this displaying will fade out and indoor units turn to normal display mode.
- ✚ After setting addresses, users can press the Silent/OK button can exit the address setting mode.
- ✚ After re-power, users can query the indoor address again: long press the UP and DOWN button simultaneously will enter the address setting page, press ON/OFF button and then press MODE button, the indoor address will be displayed on the indoor display board.
- ✚ In the address setting mode, wired controller does not respond to any command from remote controller.

Installations

1) Safety precaution

- ✚ Stated below are important safety issues that must be obeyed. Confirm there is no abnormal phenomena during test operation after complete.
- ✚ Installation by other persons may lead to imperfect installation, electric shock or fire. Improper installation may lead to electric shock or fire. A random disassembly may cause abnormal operation or heating, which may result in fire.
- ✚ Do not install the controller in a place vulnerable to leakage of flammable gases. Once flammable gases are leaked and left around the wired controller, fire may occur.

- ✚ The wiring should adapt to the wired controller current. Otherwise, electric leakage or heating may occur and result in fire. The specified cables shall be applied in the wiring. No external force may be applied to the terminal. Otherwise, wire cut and heating may occur and result in fire.
- ✚ Don't place the wired controller near the lamps, to avoid the remote signal of the controller to be disturbed. Do not install the unit and controller in a place with much oil, steam, sulfide gas. Otherwise, the product may deform and fail.

※ **Preparation before Installation:**

Make sure the following parts has been prepared.

Name	Qty.	Remarks
Wired controller	1	\
Cross round head wood mounting screw	3	M4×20 (For mounting on the wall.)
Cross round head mounting screw	2	M4×25 (For mounting on the electrical switch box.)
Installation manual	1	\
Owner's manual	1	\
Plastic expansion pipe	3	For mounting on the wall
Plastic screw bar	2	For fixing on the 86 electrician box.
Switching wires for signal receiving board	1	For connecting the signal receiving board and 4-core shield wire.
Switching wires for wired controller signal	1	(If needed) For connecting the main control panel and 4-core shielding wire.

※ **Prepare for the following at installation site.**

Name	Qty.(embedded into wall)	Specification remarks (only for reference)	Remarks
4-core shield cable	1	RVVP-0.5 mm ² ×4	The longest is 15M
86 electrician box	1	/	/
Wiring tube (insulating sleeve and tightening screw)	1	/	/

※ **Installation procedure**

- ✚ Circuit of wired controller is low voltage circuit. Never connect it with a standard 220V or 380V circuit or put it into a same wiring tube with the circuit.
- ✚ The shield cable must be connected stable to the ground, or transmission may fail.
- ✚ Don not attempt to extend the shield cable by cutting, if it is necessary, use terminal connection block to connect.
- ✚ After finishing connection, do not use mucker to have the insulation check to the signal wire.

※ **Dimensions: 120*120*20mm**

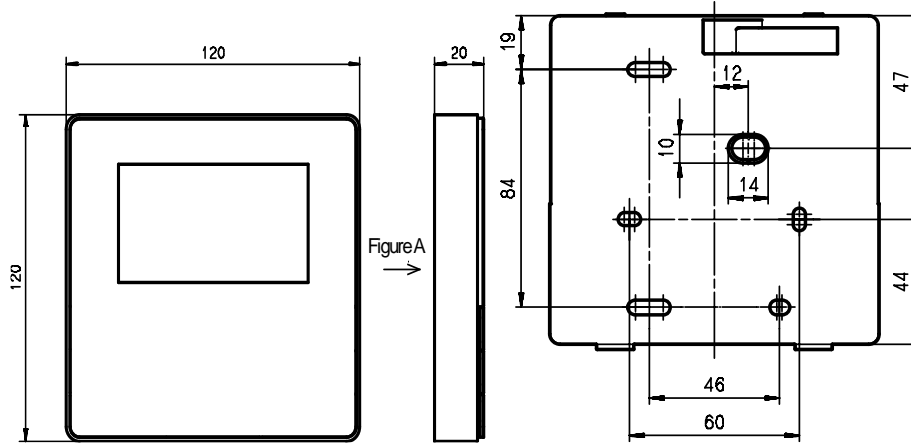

※ **Wiring principle sketch**

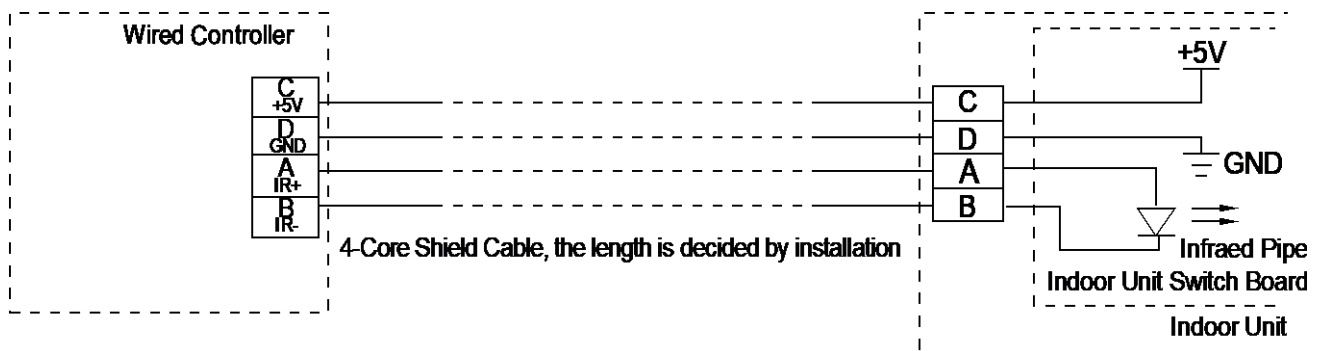

※ **Wiring figure:**

1) Connect two terminals of embedded 4-core shielding wire with the switching wires of wired remote controller and signal receiving board. Make sure the sequence of 4 terminals (A, B, C and D) should correspond to the wire sequence of signal switching wires (A, B, C and D).

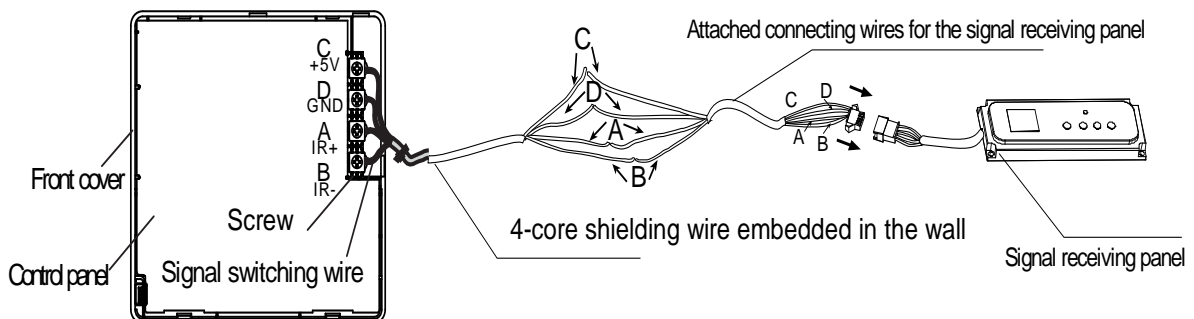

2) If embedded 4-core shielding wire cannot go through the wired controller, it can use signal switching for connection and make sure the wires are reliable and firm. The tightening torque range of the screw is 0.8~1.2N .m (8~12 kgf.cm).

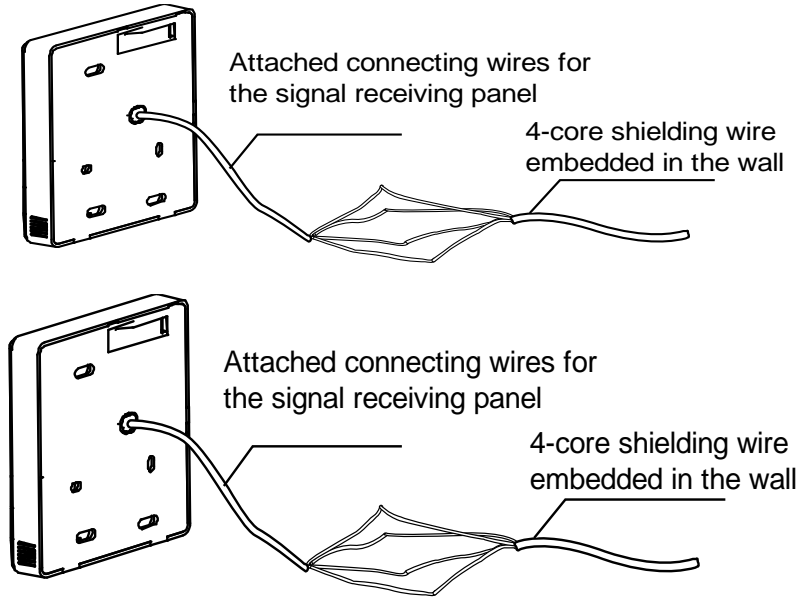

※ **Back cover installation**

1) Use straight head screwdriver to insert into the buckling position in the bottom of a wired controller, and spin the screwdriver to take down the back cover. (Pay attention to spinning direction, if not you maybe damage the back cover.)

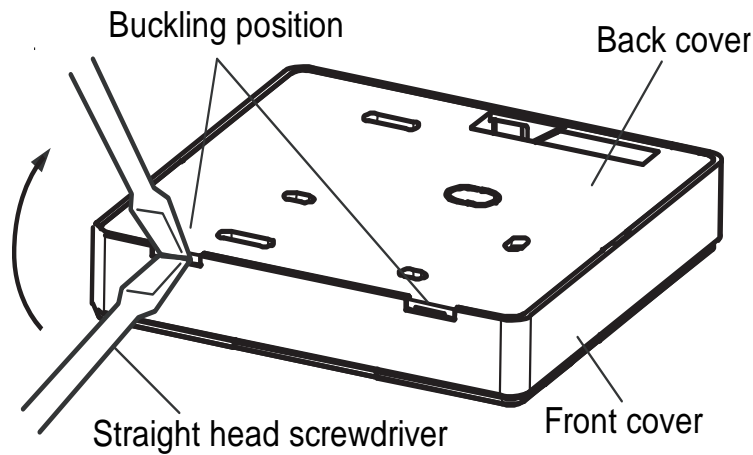

2) Use three GB950-86 M4X20 screws to directly install the back cover on the wall.

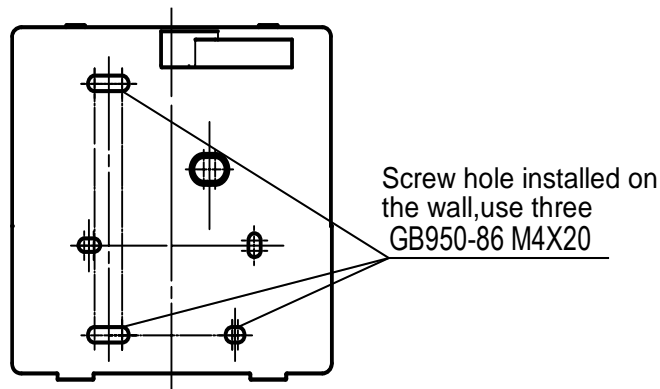

3) Use two M4X25 GB823-88screws to install the back cover on the 86 electrician box, and use one GB950-86 M4X20 screw for fixing the wall.

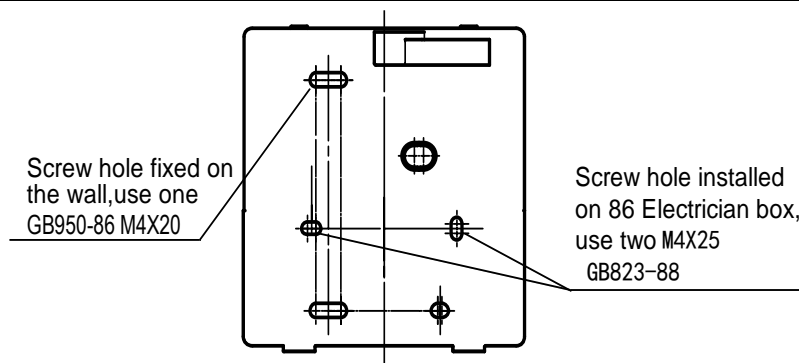

4) Adjust the length of two plastic screw bars in the accessory to be the standard length from the electrical box screw bar to the wall. Make sure when install the screw bar to the electrical box screw bar, make it as flat as the wall.

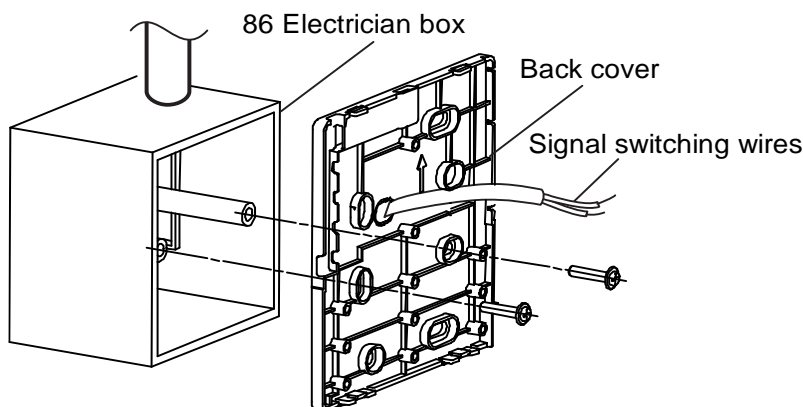

Notes:

1. Use cross head screws to fix the wired controller bottom cover in the electric control box through the screw bar. Make sure the wired controller bottom cover is on the same level after installation, and then install the wired controller back to the bottom cover.
2. Over fasten the screw will lead to deformation of the back cover.

※ **Neaten the wires**

1) There are three positions of signal wire outlet around the wired controller, when the wired controller directly is installed on the flat wall.

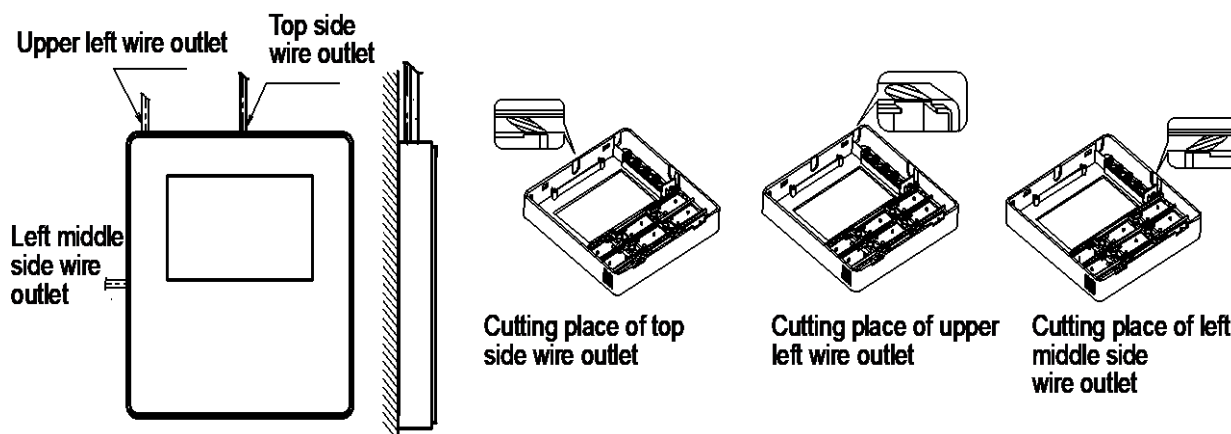

2) Shielded wiring

When the wired controller is stalled with electrician box, the back cover of wired controller is already reserved one hole for wire outlet. It is also available for the shielded wire passing by the wall.

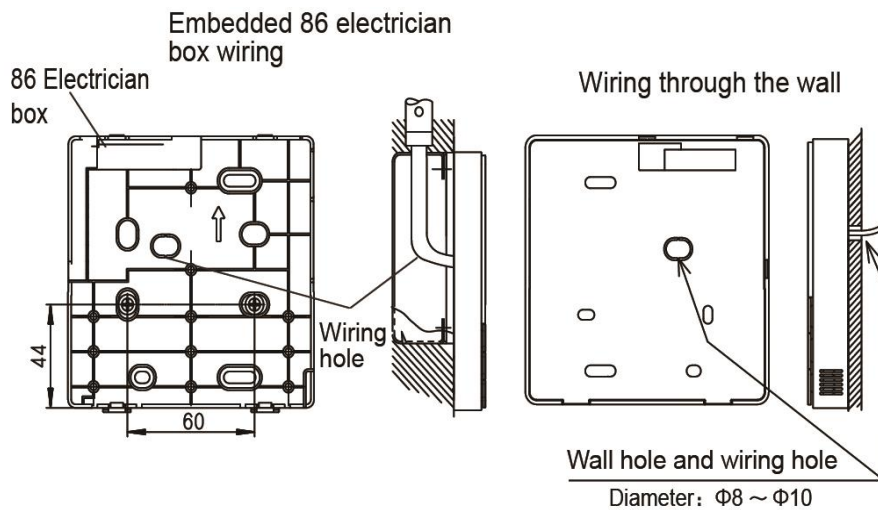

3) Avoid the water enter into the wired controller, use trap and putty to seal the connectors of wires during wiring installation. When under installation, reserve certain length of the connecting wire for convenient to take down the wired controller while during maintenance.

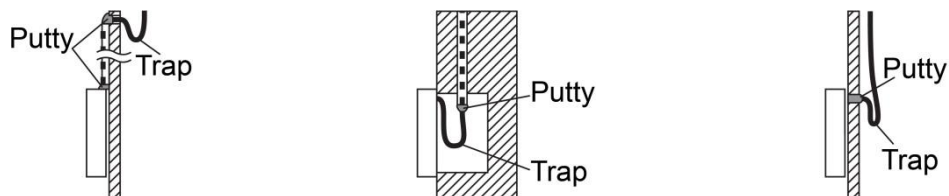

※ **Front cover installation**

1) After adjusting the front cover and then buckle the front cover; avoid clamping the communication switching wire during installation.

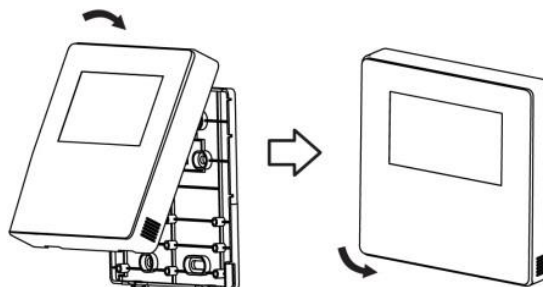

2) Correct install the back cover and firmly buckle the front cover and back cover, if not you maybe make the front cover drop off.

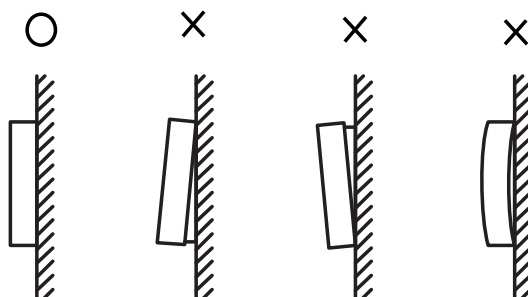

※ **Wired controller initial parameters setting:**

1. Change the related functions of the controller through adjusting the initial parameters, details refer to table 1
2. The wired controller initial parameter includes two codes "XY", the first code "X" means functions class, and the second code "Y" means the detailed configuration of this function.
3. Setting method:
 - 1) Press "Mode" and "Fan" button simultaneously for 5 seconds to enter the parameter setting state;
 - 2) The value of this first code "X" is "0"; press the temperature setting button UP and DOWN to adjust the second code value;
 - 3) After setting the second code value, press Silent/OK button to switch the first code to the next value;
 - 4) When the first code value is "6", press Silent /OK button again to exit the parameters setting.
4. The parameters setting function only under the situation which needs to adjust the default functions' setting states; otherwise do not need to be set.

Table 1

First code	Functions	Second code				
		0	1	2	3	4
0	Cool-only/ Cool-Heat selection	Cool-Heat (Default)	Cool-only	/		/
1	Indoor unit communication address setting	Yes(Default)	None	/	/	/
2	Auto-restart	Yes(Default)	None	/	/	/
3	Air filter cleaning reminding function	Cancel the reminding function	1250 hours	2500 hours (Default)	5000hours	10000 hours
5	Remote receiving function	Yes(Default)	None	/	/	/
6	Centigrade/ Fahrenheit display	Centigrade	Fahrenheit	/	/	/

Notes:

The second code of the filter cleaning reminding is 2500 hours, which as default.

Caution:

14.2.3 Central Controller: MD-CCM30



CCM30 is new designed and it is a touch key centralized controller. It can be connected up to 64 indoor units, and the connection length can be up to 1200m. The CCM30 centralized controller has the air filter cleaning reminding function and it is convenient to remind users to clean the air filter. Both of the following wiring modes centralized controller and indoor units are applicable.

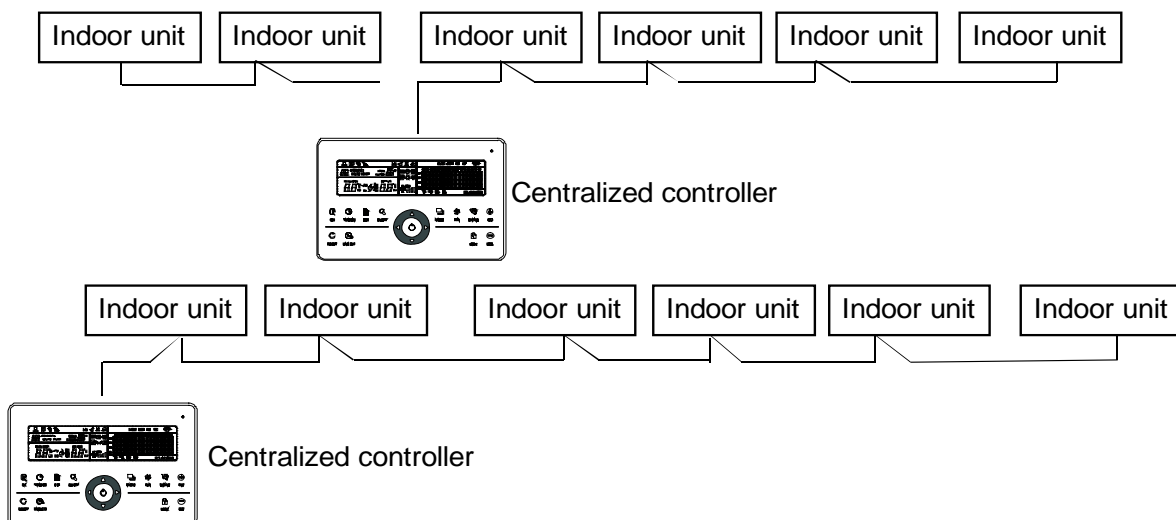

General functions and description

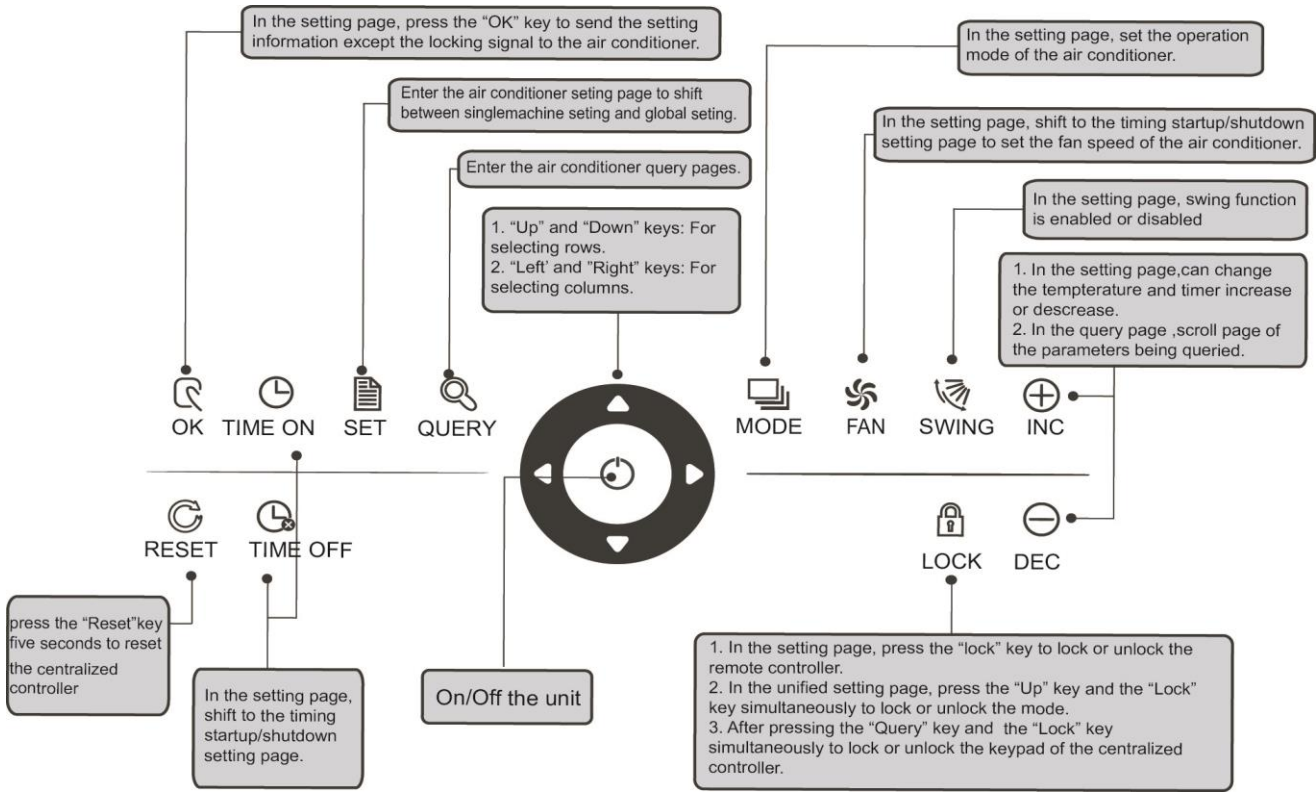

(1) Query key 

Any time when you press the key, the selected operation mode is to query the operational state of the air conditioner.

By default, the first in-service air conditioner will be queried.

(1) Setting key 

In other display modes, press this key can enter the setting mode.

By default, it is a single setting, and the first in-service air conditioner is displayed. In setting the operation mode, press this key again, and the operation will be performed for all air conditioners in the network. Press the key repeatedly to shift between a single setting and global setting.

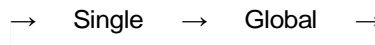

(2) Mode key 

Under the setting operation mode, press this key to set the operation.

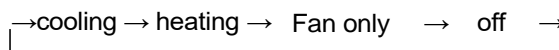

(3) Fan key  FAN

Under the setting operation mode, press this key to set the fan of the indoor unit to run in the automatic, high, medium or low level of air.

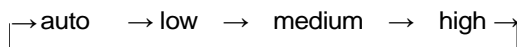

(4) Time on key  TIME ON

Under the setting operation mode, press this key can set the timing to turn on the air conditioner; press this key again can exit the timing setting, and restore the normal temperature regulation operation mode

(5) Time off key  TIME OFF

Under the setting operation mode, press this key can set the timing shutdown of air conditioner, press this key again will exit the timing setting, and restore the normal temperature regulation operation mode.

(6) Swing key  SWING

Under the setting operation mode, press this key can enable or disable the swing function. If all currently selected air conditioners have no swing function, no effect will result after pressing the key.

(7) Leftward key 

In the query mode, if this key is pressed, the operation state data of the previous air conditioner will be displayed. If it is currently on the first machine, the data of the last machine will be displayed, when the key is pressed. If you hold down this key, the address will decrease one by one. In the setting mode, if it is in single operation mode, the air conditioner of the previous in-service address number will be selected, when this key is pressed, if it is in the global operation mode, no effect will result when this key is pressed. In the main page, press the key to enter the query mode. By default, it is the first in-service air conditioner.

(8) Rightward key 

In the query mode, when the key is pressed, the next in-service air conditioner is selected, and its operational state data will be displayed. If it is currently on the last air conditioner, the first one is selected and its data displays, when the key is pressed. If this key is long pressed, the address will increase one by one.

In the setting mode, if it is in the single operation mode, when the key is pressed, the next in-service air conditioner will be selected. If it is in the global operation mode, no effect will result when the key is pressed.

In the main page, press the key to enter the query mode. By default, it is the first in-service air conditioner.

(9) Downward key 

In the main page, press this key can enter the query mode. By default, it is the first in-service air conditioner. In any other time, press this key  will select the next row corresponding position air conditioner.

In the setting mode, if the global operation mode is selected, this key is invalid. If it is on the last row, press this key again to shift to the first row air conditioner. If this key is long pressed, the row will increase one by one.

(10) Upward key 

In the main page, press this key can enter the query mode. By default, it is the first in-service air conditioner. In any other time, press this key will select the previous corresponding position air conditioner.

In the setting mode, if selected all the air conditioners to operate, this key is invalid.

If it is on the first row, press this key again, and shift to the last row corresponding air conditioner.

If you hold down this key, the row will decrease one by one.

(11) Add key  **INC**

1) Query mode:

Press this key, display the data of the last page. If it is now in the last page, press this key again and the first page will be displayed.

2) Setting operation mode

① Temperature adjusting method

Press this key; the setting temperature will increase 1 °C. If you hold down the key  "INC", the setting temperature will increase one by one.

When reached the highest allowed to set temperature, it cannot increase.

② Timing on or timing off setting method

Press this key  "INC", it will select the next setting time. If you hold down this key, the next data will be selected one by one. When reached the max. allowed setting time, it cannot increase.

(12) Reduce key  **DEC**

1) Query mode

Press this key  "DEC", display the data of the previous page. If it is now in the first page, press is key again and the last page will be displayed.

2) Setting operation mode

① Temperature adjusting method



Press this key "MINUS", the setting temperature will decrease 1°C. If you hold down this key, the setting temperature will decrease one by one. When reached the lowest allowed set temperature, it cannot decrease.

② Timing on or timing off setting method



Press this key "MINUS", it will select the next setting time. If you hold down the key "MINUS", the next data will be selected one by one. When reached the min allowed setting time, it cannot decrease.



(13) ON/OFF key

Any time when you press the key, the centralized startup/shutdown operation is performed for all current in-service air conditioners in the centralized controller network.

(14) Confirmation key

In the setting mode, press this key can send the currently selected mode state and the auxiliary function state to the selected air conditioner.

(15) Reset key

Any time when the reset key is pressed, the centralized controller will reset. The result is the same as the result of restoring power-on after power failure.

(18) Lock key

Any time when this key is pressed, the selected air conditioner can be locked or unlocked.

LED display

Full display of LCD

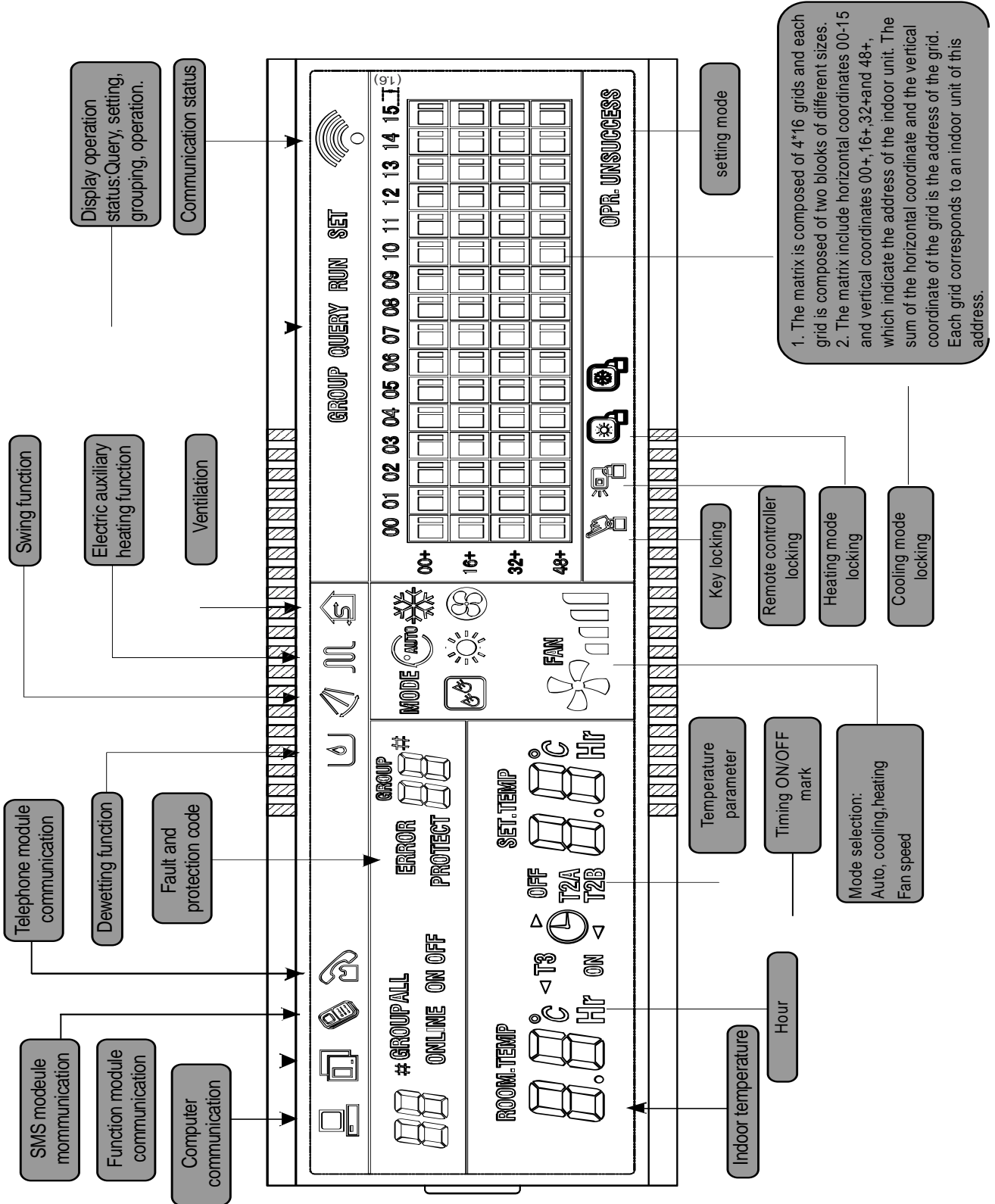

Other operations

※ Various locking functions

1. Centralized controller locking

The centralized controller locking state will be recorded when powered off. It won't dismiss when re-power on until receiving the unlocking order.

1) Effect

① When the centralized controller is under locking state, it cannot change the air conditioner's operating state through the centralized controller (such as ON/OFF the unit, setting mode, change the setting temperature, change the fan speed, unlock the exiting locking state etc.), but it can do the query operation, until unlocking and then recover to normal.

② When the centralized controller is under the locking state, all the air conditioners in the centralized controller network will be remote controller locked.

2) Operation

① Locking

The centralized controller can be locked by the computer only.

② Unlocking

a) When the centralized controller and computer communicate normally

The centralized controller can be unlocked by the computer only. When the centralized controller is unlocked, the controller will send the order to unlock the remote controller locking of all the air conditioners.

b) When the centralized controller and computer communication abnormally

When the centralized controller is locking, the centralized controller can be unlocked by the way that the press QUERY key and holds on, then press MODE key (it should operate within one minute after centralized controller is re-powered on or the RESET key is pressed).

The remote controller locking of the air conditioner is remained.

2. Remote controller locking

1) Effect

① When the air conditioner is under remote controller locking state, it will not receive the remote signals from remote controller or wired controller, until unlocking.

② The air conditioner can be operated by the centralized controller.

2) Operation

① Can lock or unlock through the computer.

② Can operate by a centralized controller.

In the centralized controller setting interface, press LOCK key to lock or unlock.

If the current state is remote controller locking, press the key to unlock.

If there's no remote controller locking, press the key to lock.

3. Mode locking

1) Effect

Under the mode locking state, only can choose the mode which hasn't conflict with locking mode through centralized controller to operate the air conditioner,

2) Operation

Can set the heat and cool mode lock or not

Under mode locking state, if set the new mode locking, it must be unlocking first, then can operate the new mode locking.

① Can lock or unlock through the computer.

② Can operate by a centralized controller.

In the centralized controller setting interface, choose all the air conditioners of the centralized controller network as the object, press Upward key and hold on, then press LOCK key to do the mode locking or unlocking.

If the current state is mode locking, press the key to unlock.

If there isn't a mode of locking, press the key to lock.

※ Power on or reset

When the centralized controller is powered on or resets by the RESET key:

The buzzer long buzz for 2 seconds: all display segments of the LCD are luminous for 2 seconds and then goes off;

1 second later, the system enters normal display state. The centralized controller is in the main page display state and displays the first page, and searches the in-service air conditioners in the network.

Once the search is finished, the centralized controller enters the mode setting page, and sets the first in-service air conditioner by default.



※ Emergency stop and forced on

When the emergent stop switch of the centralized controller is connected, all the air conditioners in the centralized controller network will be shut down compulsorily, and the LED flashes as 0.5Hz. The centralized controller and computer and all functional modules are disabled from startup and shutdown until the emergent stop switch is broken. When the forced on the switch of the centralized controller is connected, all air conditioners in the network of the centralized controller will start up compulsorily. By default, they will run before the power failure mode.

The startup and shut down operations of the centralized controller and computer and all functional modules will be disabled (only the command of a startup is sent to the air conditioner, without affecting operation of the remote controller after startup) until the forced on the switch is broken.



If the foregoing two switches are connected concurrently, the emergent stop switch shall have preference.

※ ON and OFF operation

Use the " " key or " " key can turn on and turn off the air conditioners in the centralized controller network. The ON mode will accord to the system mode locking or other limit conditions for judging, if there is conflict, it will auto adjust to the next mode without conflict; if all the modes have a conflict, then it cannot operate the unit.

※ Use " " key to TURN ON and TURN OFF the unit

Press this key can operate a single air conditioner or all the air conditioners in the centralized controller network.

1) Choose the object. Press SET key to choose a single air conditioner or all air conditioners in the centralized controller network. If choose a single air conditioner, then use the keys , ,  and

 can choose the air conditioner.

2) Use "MODE", "FAN", "ADD" and "Reduce" key to set the operating mode and operating parameters, such as fan speed, setting temperature etc.

3) Use " " key, centralized controller sends the relative order to the operating object.

After setting the operating parameter for the air conditioner, if not press the key " ", the setting parameter

will not be sent to the air conditioner, and the current operation of the air conditioner is not affected (except locking operation).

※ **Use "⏻" key to TURN ON and TURN OFF the unit**

Only can operate all air conditioners, not for single in the centralized controller network:

Long press "⏻" key: press this key for over 2 seconds then loose.

Short press "⏻" key: press this key and then loose within 2 seconds.

According to different states and operation ways of air conditioners in the current centralized, there are following situations:

1) If there are one or more air conditioners is under ON state (include timing process of timing ON and OFF),

"⏻" key only short press effective.

Only sends the shutdown order to the air conditioner which under the ON state, and if the unit is under the OFF state, the controller will not send OFF order to it.

The memory function is activated; the current state of all air conditioners is memorized.

2) All the air conditioners in the centralized controller network are OFF states.

① Short press "⏻" key

The centralized controller reads the memory contents, and sends relative order to all air conditioners.

② Long press "⏻" key

a) If current page is setting parameters, and the setting mode is not OFF, the centralized controller will send orders to all air conditioners according to parameters, such as setting mode, fan speed, setting temperature, etc.

b) If the current is under setting interface but the setting mode is OFF state or under other interfaces, the centralized controller will send the default ON order to all air conditioners. The default ON order is: cooling mode, high fan speed, setting temperature is 24°C or 76°F, operates the swinging function.

※ **Air filter cleaning remind display description**

1) The centralized controller records the total running time of the indoor unit.

When the accumulated running time reaches the pre-set value, the reminding dual "88" (as show in c part of the Fig. A) will display "FL" to remind users that the air filter of the indoor unit need to be cleaned.

When the centralized controller displays FL, it needs to manual operation to clear the icon. Press SWING key

and hold on then press QUERY key "QUERY", can clear FL reminding.

At the same time, the accumulated time of centralized controller powered on will be cleared.

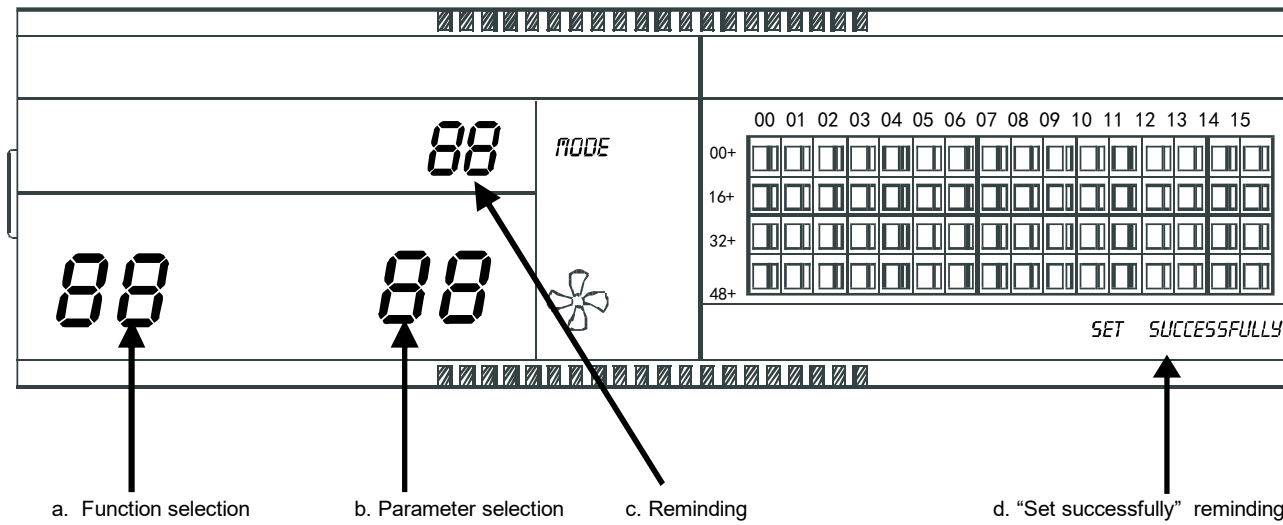

Fig. A

2) Function setting

① Dial the dial code 3 to "ON" (refer to table 2.3), and when controller power on within 1 minute, press QUERY key and FAN key together will enter the optional function setting page. The icon **88** (as show in b part of the Fig. A) will be flashed with 1Hz frequency (default display 00), and users can choose the function from table 2.2.

Press "INC" and "DEC" keys can select function, and then press "OK" key to enter parameter selection.

① After entering parameter selection, the function selection icon **88**(as show in a part of the Fig. A) will be lighted on; the parameter selection icon **88**(as show in b part of the Fig. A) will be flashed with 1Hz frequency and display optional parameter code. Through pressing "INC" and "DEC" keys can select the detailed parameter.

② Press "OK" to confirm parameter selection (details parameter codes' corresponding time refer to table 2.3).

③ After setting successfully, the function selection icon **88**and parameter selection icon will be lighted on, the screen will display "Setting successfully" (as show in b part of the Fig. A). After 3 seconds will exit optional function setting automatically, and the screen will be back to normal display. After entering optional function setting, no operations in 5 seconds will exit function selection automatically, the setting parameter

will not change. Only press "OK" key to confirm the parameter then the setting parameter will save.

Table 2.1: The code of selecting the clear filter function

Function code	Function setting
00	Only display, no function
01	Cleaning filter screen reminding

Table 2.2: The code of different times of reminding clear filter

Parameter code	Time (hour)
00	0
01	1250
02	2500
03	5000
04	10000

※ Dial code operation specification

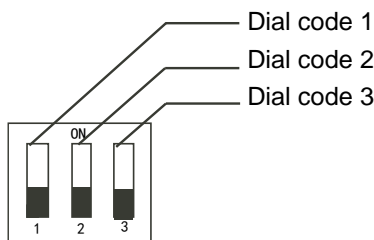

Table 2.3

	ON	OFF
Dial code 1	CCM30 for 3-pipe	CCM30 for 2-pipe
Dial code 2	Fahrenheit	Centigrade
Dial code 3	With the optional function	No the optional function

Notes:

1. For the new series product, we can connect the indoor CCM controller via XYE port of master outdoor unit of every refrigerant system. Notice that in this case, the outdoor unit must be set to auto addressing mode. And it will be effective after about 6 minutes.
2. To connect indoor CCM controller via XYE port of indoor unit, this wiring method is suitable for all type of indoor units, not just for new indoor units.
3. When new indoor units and old indoor units mix connect to one refrigerant system, we can just connect the indoor CCM controller via XYE port of indoor units. If we connect the indoor CCM controller via XYE port of master outdoor unit, the CCM controller cannot control old indoor units.
4. If one system that connect to indoor CCM controller include 10 HP or above duct indoor unit, we recommend

you set the address of every indoor unit manually.







Fault and protection codes



Fault code	Content
EF	Other faults
EE	Water level detection malfunction
ED	Reserved
EC	Cleaning malfunction
EB	Inverter module protection
EA	Current of compressor is too large (4 Times)
E9	Communication malfunction between main board and display board
E8	Wind blowing speed is out of control
E7	EEPROM error
E6	Detection of current direction alternating is abnormal
E5	T3 or T4 sensor of discharge of compressor fails down
E4	T2B sensor malfunction
E3	T2A sensor malfunction
E2	T1 sensor malfunction
E1	Communication malfunction
E0	Phase sequence disorder or loss of power phase
07#	/
06#	/
05#	/
04#	/
03#	Communication malfunction between centralized controller and PC(gateway)
02#	Communication malfunction between centralized controller and functional module
01#	Communication malfunction between centralized controller and network interface module
00#	Communication malfunction between network interface module and main control board

Protection code	Content
PF	Other protection
PE	Reserved
PD	Reserved
PC	Reserved
PB	Reserved
PA	Reserved
P9	Reserved
P8	Compressor's current is too large
P7	Voltage of power supply is too high or too low
P6	Pressure of discharge is too low
P5	Pressure of discharge is too high
P4	Temp. of discharge pipe is abnormal
P3	Temp. of compressor is abnormal
P2	Condenser high-temperature protection
P1	Anti-cool air or defrost protection
P0	Evaporator temperature protection

General display data entries

1) General display data is displayed in all display pages.

- Under the interconnected control of the computer or gateway, the data is displayed in graphic (). Otherwise, no data is displayed.
- If the centralized controller is connected with the functional module for communication, the data is displayed in graphics (). Otherwise, no data is displayed.
- In normal operation of the centralized controller, the periodical cycle module communicates with the network interface module, and the data is displayed dynamically and cyclically: (blank),  ,  ,  .
- In the centralized control locked state or the keypad locked state, the locking flag () is displayed. After unlocking, it is not displayed. In the centralized controller locked state or the keypad locked state, the locking flag is displayed constantly. If both of them are locked concurrently, the locking flag is displayed constantly.

- In the setting page, if the selected air conditioner is in the remote controller locked state (in case of non-single unit operation, as long as one unit is in the remote controller locked state, it is deemed the locked state), the flag () is displayed constantly.
- If all indoor units lock the cooling mode, this flag () will display, and if all indoor units lock the heating mode, the flag () will display.

2) Data display handling

- Indoor unit code (address) display: display range: 00~63, and with # being luminous concurrently.
- Indoor temperature display: display range: 00~99°C (or 99°F). The indoor temperature is displayed concurrently. If the temperature is higher than 99°C (or 99°F), 99°C (or 99°F) will be displayed. If the temperature value is invalid, '--' will be displayed.
- If timing startup or shutdown is set, the flag () is displayed.
- T3, T2A and T2B display: in the single-machine query page, display can shift between T3, T2A and T2B; by the way, the temperature value is displayed concurrently, with the corresponding °C being luminous.
- In case of air conditioner fault or protection, the corresponding fault or protection code, the corresponding fault or protection code can be displayed.
- Liquid crystal matrix display description:

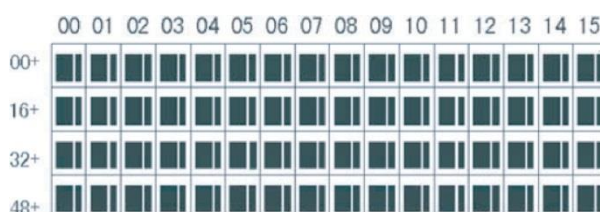

The liquid crystal matrix is composed of 4x16 grids, and each grid is composed of two blocks of different sizes. The matrix includes horizontal coordinates 00~15 on the upper side and vertical coordinates 00+, 16+, 32+ and 48+ on the left side, which indicate the address of the indoor unit. The sum of the horizontal coordinate and the vertical coordinate of the grid is the address of the grid. Each grid corresponds to an indoor unit of this address. One grid is composed of two blocks of different sizes. The state indication table is as follows;

	Constantly on	Slow blink		Fast blink
Big black block	In-service	Selected		Out of service
Small black block	Power on		Fault of indoor or outdoor unit	Power off

3) LCD display description

- **Description of the main page**

The LCD displays the main page, 60 air conditioners are in service, of which 28 are powered on and 32 off.

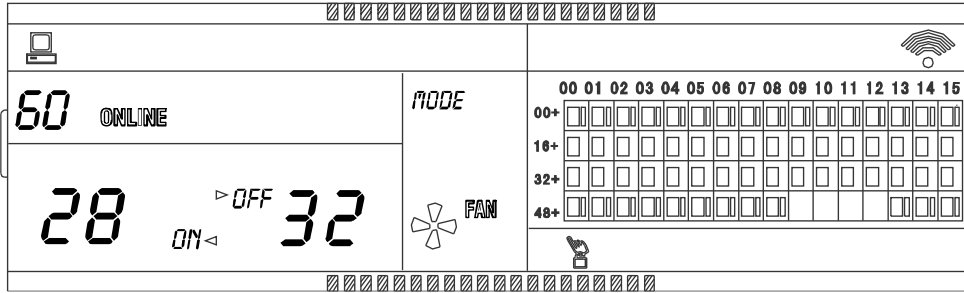

In the matrix, the big dots from (16+, 00) to (32+, 15) are luminous, and the small dots are not luminous. It indicates the 32 air conditioners with the addresses from 16 to 47 are powered off.

In the matrix, the big and small dots from (48+, 09) to (48+, 12) are not luminous. It indicates the four air conditioners with the address from 57 to 60 are outside the network.

All other big and small dots in the matrix are luminous. It indicates all other air conditioners are in the network and powered on.

The address of the air conditioner is sum of the coordinates. For example, the address of (48+, 09) is 09+48=57.

● Description of the query page

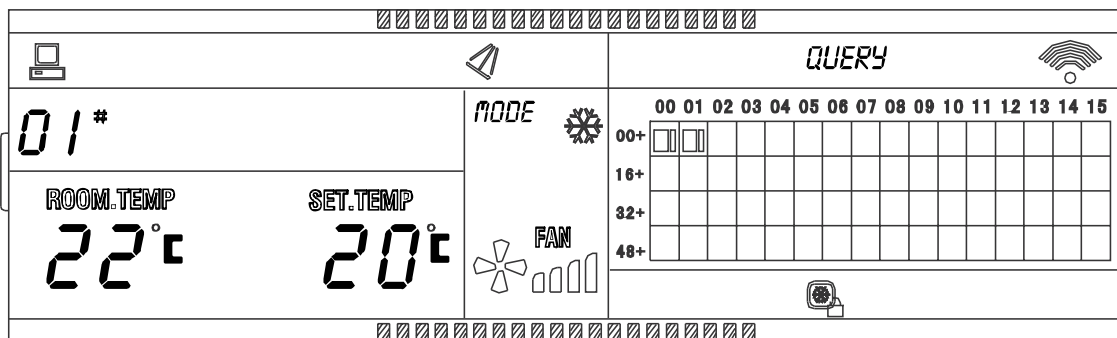

The LCD displays the query page, and the air conditioner with the address of 01 is being queried. Mode of the air conditioner with the address 01 is cooling, high speed air supply, swing on, indoor temperature 22°C, setting temperature 20°C and cooling mode locked.

In the matrix, only the big and small black dots at (00+, 00) and (00+, 01) are luminous. It indicates the in-service and power-on state of the air conditioners with the addresses of 00 and 01.

● Description of the setting page

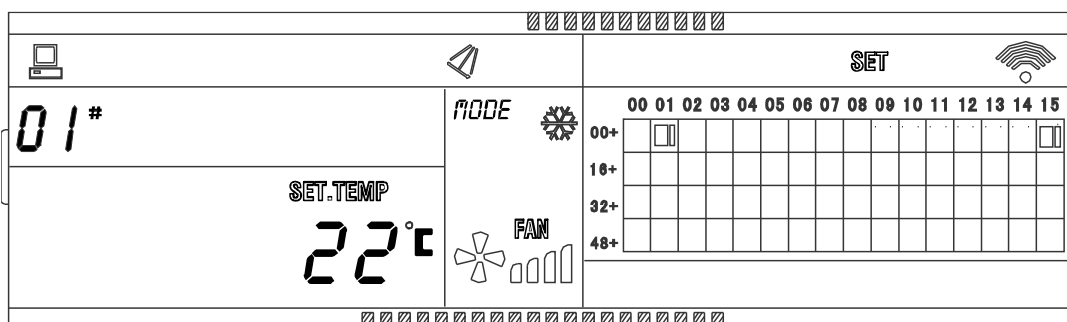

The LCD display displays the setting page, and queries the air conditioner with the address of 01.

The mode of the air conditioner with the address 01 is: Cooling, high fan speed, swing on, setting temperature 22°C and cooling.

In the matrix, only the big black dots at (00+, 01) to (00+, 15) are luminous. It indicates the air conditioners with the addresses 01 and 15 are in service.

● **Fault page display description**

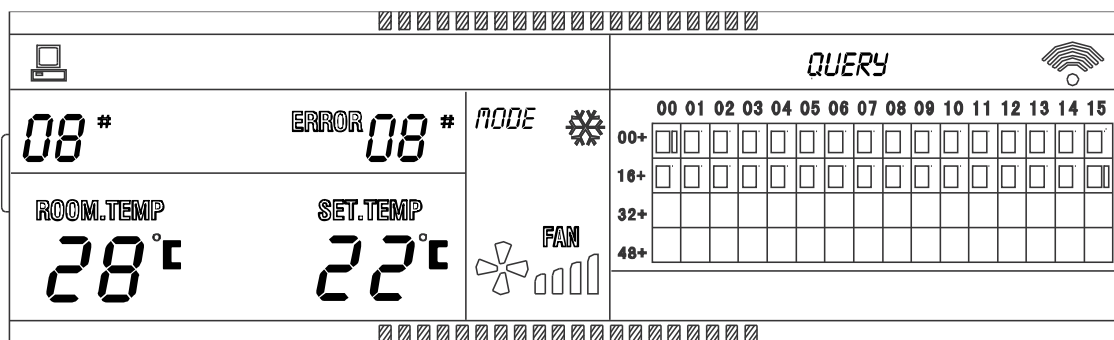

Query the air conditioner with the address of 08 in the query page.

The air conditioner with the address of 08 is faulty, and fault code is 08. The big black dot below (00+, 08) blinks.

In the matrix, only the big and small black dots at (00+, 00) and (16+, 15) illuminate. It indicates the in-service state of the air conditioner power on, with the addresses 00 and 31.

Centralized controller installation

※ **Dimensions (Unit: mm)**

There are two kinds of appearance for your choice. The main difference is the controller cover and you can choose you like.

(1) The structure A must be embedded into the wall of the installation mode, taken from the walls of the interior wiring way would be more appropriate; and you must reserve a chisel installation on the wall before installation.

(2) The structure B does not need to be embedded into the wall, playing four mounting screw mounting and shape is a regular cuboid, can also like the old structure embedded in the wall mounted, connecting line from the set control above and below, and a rear leading-out.



CCM30/BKE-A



CCM30/BKE-B

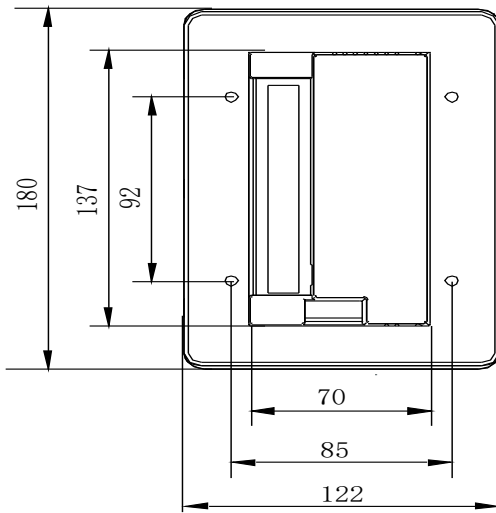

CCM30/BKE-A

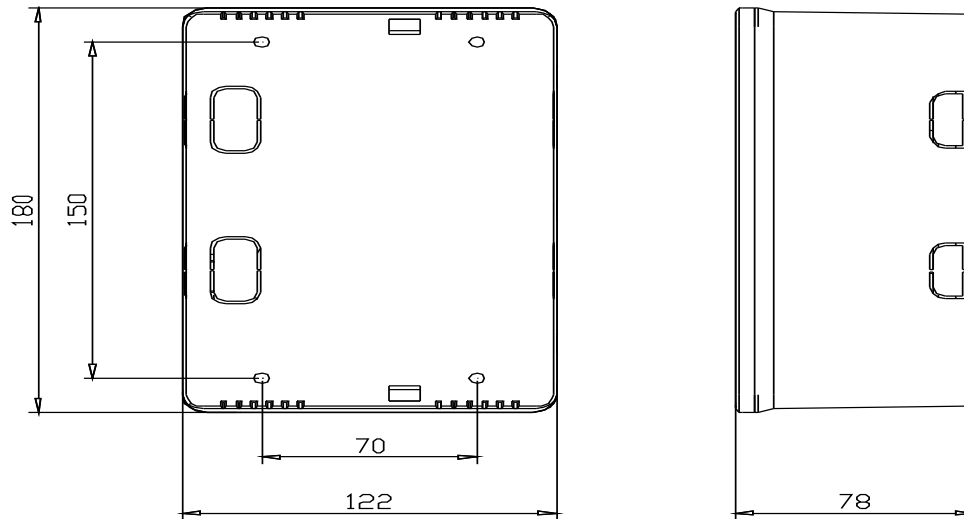

CCM30/BKE-B

※ Installation diagram

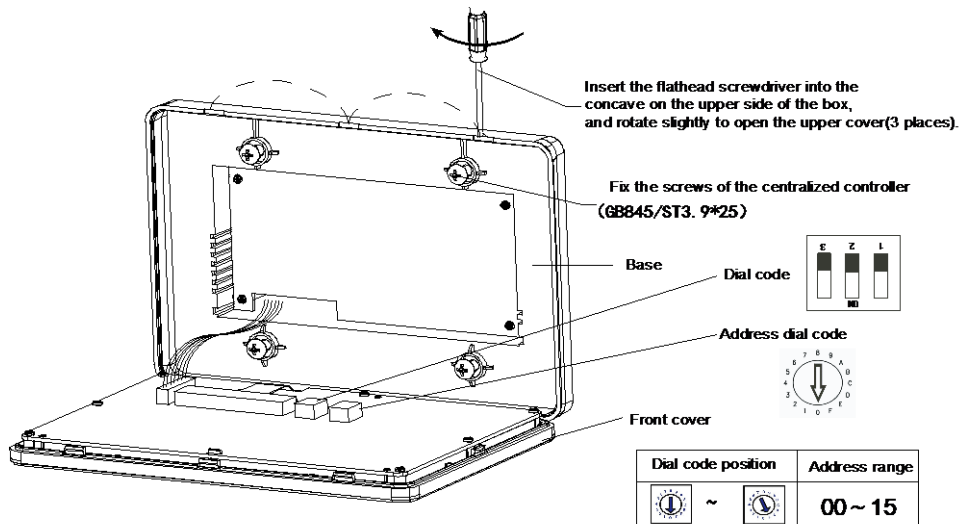

※ Terminal instruction

