

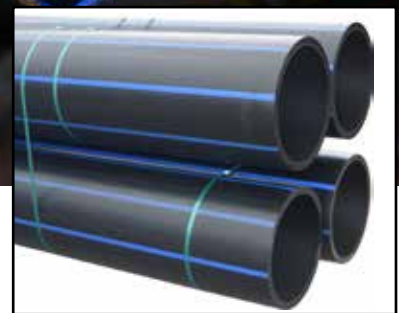

# Water distribution system



Manufacturer of heating,  
water, gas and sewerage systems

Download the catalog:



## PAS 1075 Type 3 Certification

**DIN CERTCO**  
Gesellschaft für Konformitätsbewertung mbH

# CERTIFICATE

**Certificate holder** Valrom Industrie srl  
Bdul. Preciziei, nr 28, sector 6  
062204 Bucuresti  
ROMANIA

**Production facility** Bucharest

**Product** Pressure pipes made from Polyethylene (PE) for alternative installation techniques - PE 100-RC

**Classification** EG 926.2, Outside diameter

**Type, Model** waterPro

**Remarks to the type** PAS 1075 Type 3/2 - TW  
Basis DIN EN 12201-2

**Testing basis** PAS 1075:2009-04  
Certification Scheme Pla

**Mark of conformity** 

**Registration No.** P1R0522

**Valid until** 2023-02-28

**Right of use** This certificate in conjunction with See annex for fur

2018-02-14  
Dipl.-Wl.-Ing. (FH)  
Head of Certificati

DIN CERTCO Gesellschaft für Konformitätsbewertung mbH

**DIN CERTCO**  
Gesellschaft für Konformitätsbewertung mbH

# ZERTIFIKAT

**Zertifikatinhaber** Valrom Industrie srl  
Bdul. Preciziei, nr 28, sector 6  
062204 Bucuresti  
RUMÄNIEN

**Herstellwerk** Bukarest

**Produkt** Druckrohre aus Polyethylen (PE) für alternative Verlegetechniken - PE 100-RC

**Klassifizierung** EG 926.3, Außen-Durchmesser 250 mm bis 630 mm

**Typ, Modell** waterPro

**Erläuterungen zum Typ** PAS 1075 Typ 3/2 - TW  
Basis DIN EN 12201-2

**Prüfgrundlage(n)** PAS 1075:2009-04  
Zertifizierungsprogramm Kunststoffrohrsysteme (Druckrohre und -formstücke) (2017-05)

**Konformitätszeichen** 

**Registernummer** P1R0523

**Gültig bis** 2023-02-28

**Nutzungsrecht** Dieses Zertifikat berechtigt zum Führen des oben stehenden Konformitätszeichens in Verbindung mit der genannten Registernummer. Weitere Angaben siehe Anhang.

2018-02-14  
Dipl.-Wl.-Ing. (FH) Sören Scholz  
Leiter der Zertifizierungsstelle

DIN CERTCO Gesellschaft für Konformitätsbewertung mbH · Alboinstraße 56 · D-12103 Berlin · www.dinertco.de

May 2022 Issue

The information and statements contained in this document are supposed to be accurate and complete at the drafting date. Valrom Industrie s.r.l. assumes no responsibility for any loss, degradation or damages, direct or indirect, arising from or due to the use of the information contained in this document. The images are for information purposes and do not give rise to contractual obligations. Valrom reserves the right to modify data in the catalogue without prior notice.



## HDPE pipes

VALROM Industrie produce WaterPRO series, a new generation of HDPE pipes for water networks. It was designed for better handling, storage and installation and decrease of costs related to this operations.

The core is a PE100 or PE100 RC pipe, for water (SDR11+SDR26) networks, according to relevant applicable standards and local regulations. At the outside it has an outer PP layer, applied since extrusion stage (coextrusion) to increase the scratch and penetration resistance. This layer also protect the pipe from mechanical damage and UV radiation.

Underneath the protective layer can be inserted a stainless steel thread for detecting the pipe.

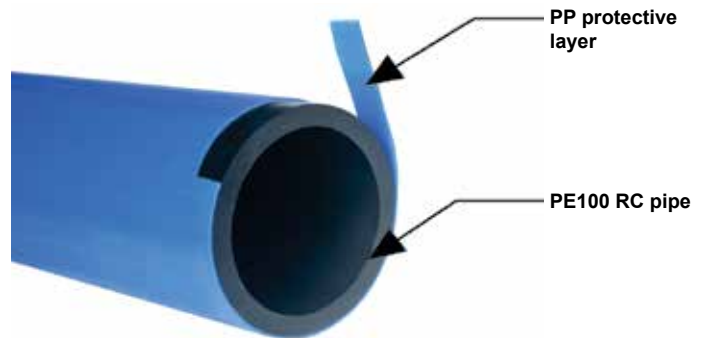

## Conformity

PE100 pipe fulfills requirements of EN 12201-2, annex C („Plastics piping systems for water supply and for drainage and sewerage under pressure - Polyethylene (PE) – part 2: Pipes, Annex C Pipes with peelable layer“). PE100 RC pipe fulfills requirements of PAS 1075 – Pipes made from polyethylene for alternative installation techniques. Dimensions, technical requirements and testing.

## Technical specification pas 1075–2009

### About PAS 1075

A publicly available specification – PAS is a supplement to existing standard and guidelines published by Deutsches Institut für Normung. It was initiated by a professional association and does not replace existing standards or regulations. PAS 1075:2009 (“Pipes made from polyethylene for alternative installations techniques. Dimensions, technical requirements and testing”) refers to properties, requirements and test methods for HDPE pipes intended for alternative laying installation (no sand with reuse of excavated soil or trenchless methods)

### PAS 1075 requirements

This documents defines a new HDPE class, PE 100 RC, with high resistance to slow crack propagation and certification requirements for booth material and pipe.

### Failure modes of HDPE pipe

Slow crack growth - the slow development of a crack initiated by external point loads or a scratch during transport or installation.

### Propagation of crack

In time, it has been observed, the most defects in high pressure polyethylene pipe in operation are caused by the propagation of slow cracks .

These are characterized by slow development of a crack initiated in the point of a static load (a stone with sharp edges that press the pipe wall) or an scratches during transport or installation.

Slow crack growth resistance it's critical to a polyethylene pipe that is installed by unconventional technologies where scratching is unavoidable.





Comparison between standard pipe type and PAS 1075.

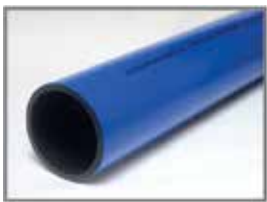

**PAS 1075 type 3**

**PE100 RC doublelayer pipe** with additional PP external layer.  
Dimension: acc EN 12201-2  
External layer is in addition to pipe thickness.

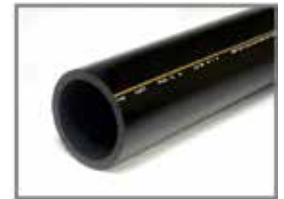

**Standard**

**PE100 monolayer pipe**  
Dimensions acc EN 12201-2

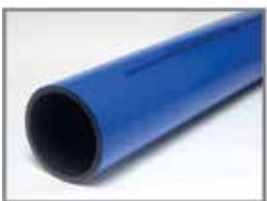
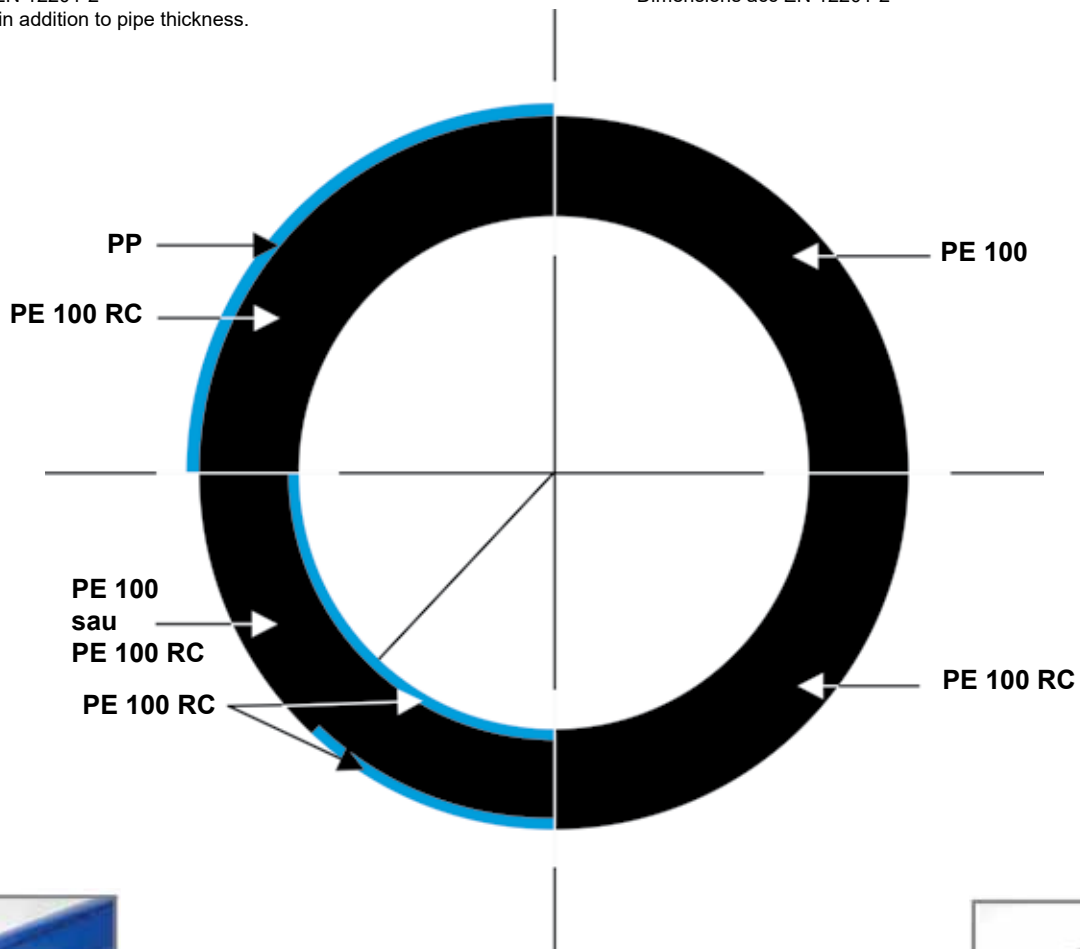

**PAS 1075 type 2**

**Doublelayer PE100 or PE100 RC pipe** with integrated PE 100RC internal layer. Dimensions acc EN 12201-2.  
**Triplelayer PE100 sau PE100 RC pipe** with integrated PE100 RC internal and external protection layer. Dimensions acc EN 12201-2.



**PAS 1075 type 1**

**Monolayer PE100 RC pipe.** Dimension acc EN 12201-2.



### Advantages of WaterPRO pipes compared to conventional pipes

#### Protection from mechanical damage

The outer layer is made from special additivated PP material to ensure scratch and penetration resistance (up to 3 times tougher than high density polyethylene <sup>1</sup>). This makes possible installation without sand. Any deterioration over allowable limit is easily seen due to different colors of the protection layer.

#### Installation cost decrease

A decrease up to 10% in installation costs is possible due to sand elimination and the workmanship.

#### Peelable layer

Is easy to move away the outer layer through peeling allowing for standard join techniques: butt welding or electrofusion. This preliminary operation takes only a gimp and it can be done on site with dedicated tools.

#### Protection

The outer PP layer protects the pipe against UV radiation and prevents contamination through oxidation and dirt.

#### Pipe detection

The pipe is equipped with a stainless steel thread enabling localization of pipe position.

### Application

#### 1. Open trench installation without sand bend (WaterPRO PE100)

The outside additional PP layer, protect the pipe, this make possible installation without sand bend. Upon installation, the excavated earth can be used to fill the ditch, if it can be compacted. It should not contain stones or other residues with sharp or blunt edges or corners. The ground must sustain the pipe evenly over the entire circumference.



#### 2. Horizontal directional drillig (PE 100 RC)

Application: for the construction of new or the reconstruction of old pipelines.

Advantages of the method: is suitable for areas where trench works must be avoided due to, for instance: rivers, roads and railroads, squares, buildings, etc.



#### 3. BurstLining (PE100 RC)

Application:

- if the old pipeline is heavily deformed;
- the diameter of the pipeline does not conform with the new requirements.

Advantages of the method:

- the reconstruction of new pipeline is possible, indifferent the material of the old pipeline (ceramic, concrete, cast iron, steel etc)
- the flow rate parameters of the new pipe, are higher or equal to the capacity of the reconstructed pipe.
- compact equipment permits operation in restricted condition.



#### 4. Relining (PE100 RC)

Application: for reconstruction of old pipelines.

Advantages of the method: only the beginning of the pipeline span that has to be reconstructed and junctions of the pipe are excavated during the works.





### Marking and identification

For WaterPRO the core pipe is black with a blue outer layer. Marking is done according to the relevant applicable standards, with white or black ink on the outer layer.



### Peeling steps



Measure and mark on the pipe the length of the segment which has to be removed.



Use the special tool to cut around the outer layer.



With the same tool cut the segment on his length.



Remove the outer layer.

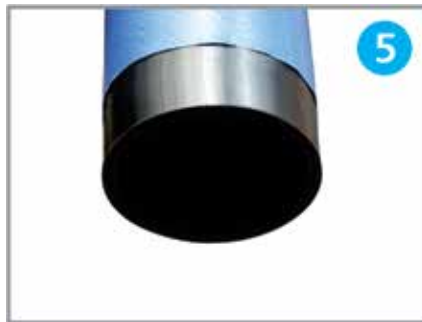

Prepare the fresh surface for jointing.

### Pipe detection

Detection accurately at the Waterpro pipes with stainless steel wired is done by applying a signal to a transmitter that will generate an active signal. Terminals transmitter connects directly to stainless steel wire and an appropriate grounding device. The frequency receiver setting to detect the position of buried pipe.

- The signal can be transmitted for distances of 100 m. Increase distance for models with higher power transmitters  
When the pipe it is a greater depth you will have a signal with higher frequency, which will decrease the distance that propagates. If the depth is about 1.5 meters, then you can choose a lower frequency and the distance will increase.
- According to signal distance propagation, access road to the tracer wire will be provided.
- According distance signal propagation routes will be provided roadways to stainless steel wire. In the event of disruption caused by the omission of connecting wire stainless steel can generate an inductive signal over the pipe. Detection is not as accurate as direct connection but is useful.

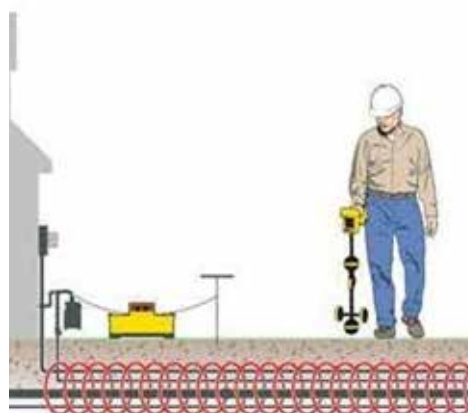

The pipe detection by direct connection to the metal wire.

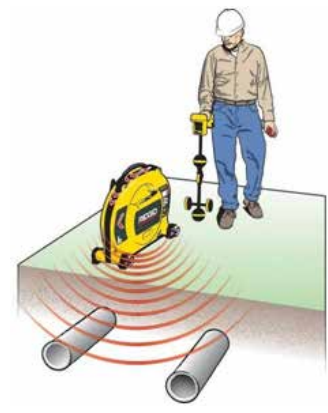

For the localization of the pipe, a signal is induced.



**Legend:**

**SDR**, Standard Dimension Ratio is an integer approximately equal to the ratio of the nominal outside diameter (**Dext**) and the tube wall thickness (**e<sub>n</sub>**).  
**PN** is the allowable operating pressure (bar), PFA according to EN 805, which may be borne to transport water at 20°C, 50 years period of use. In case of using PE pipes consistently at a higher temperature of 20°C, max. 40°C, then the maximum pressure and the life time are reduced, more details in the technical manual.

- e<sub>n</sub> - Nominal wall thickness
- g - Minimal thickness protective PP layer
- C - Safety coefficient

**“WaterPRO” PE100RC pipe for potable water with protective PP layer and metallic wire for detection**

**SDR11 PN16**

Dext. [mm]	e <sub>n</sub> [mm]	g [mm]	Weight [kg/m]	L [m]		Code
90	8,2	0,8	2,540	100		WPR716110090100*
90	8,2	0,8	2,540	13	871	WPR716110090013*
110	10,0	0,8	3,662	100		WPR716110110100*
110	10,0	0,8	3,662	13	559	WPR716110110013*
125	11,4	0,8	4,655	13	299	WPR716110125013*
140	12,7	0,8	5,731	13	260	WPR716110140013*
160	14,6	0,8	7,405	13	182	WPR716110160013*
180	16,4	1,0	9,466	13	143	WPR716110180013*
200	18,2	1,0	11,539	13	182	WPR716110200013*
225	20,5	1,0	14,445	13	143	WPR716110225013*
250	22,7	1,0	17,612	13	91	WPR716110250013*
280	25,4	1,0	21,873	13	65	WPR716110280013*
315	28,6	1,2	27,839	13	65	WPR716110315013*
355	32,2	1,2	35,002	13	26	WPR716110355013*

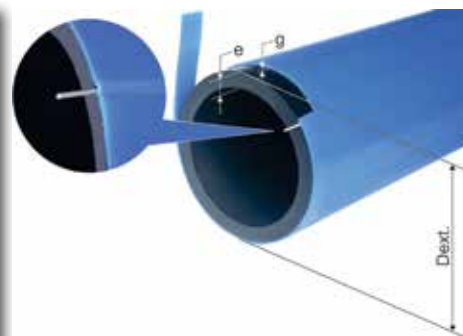

**Material:** PE100 RC (resistant to cracks), PP peelable layer.

Underneath the protective layer is inserted a stainless steel thread for detecting the pipe.

**Reference standards:**

EN EN 12201, PAS 1075 Type 3

**Use:** in water under pressure networks, for alternative installation techniques (horizontal directional drilling, relining etc.).

**SDR17 PN10**

Dext. [mm]	e <sub>n</sub> [mm]	g [mm]	Weight [kg/m]	L [m]		Code
75	4,5	0,8	1,365	100		WPR710170075100*
75	4,5	0,8	1,365	13	1352	WPR710170075013*
90	5,4	0,8	1,873	100		WPR710170090100*
90	5,4	0,8	1,873	13	871	WPR710170090013*
110	6,6	0,8	2,671	100		WPR710170110100*
110	6,6	0,8	2,671	13	559	WPR710170110013*
125	7,4	0,8	3,329	100		WPR710170125100*
125	7,4	0,8	3,329	13	299	WPR710170125013*
140	8,3	0,8	4,097	13	260	WPR710170140013*
160	9,5	0,8	5,241	13	182	WPR710170160013*
180	10,7	1,0	6,745	13	143	WPR710170180013*
200	11,9	1,0	8,196	13	143	WPR710170200013*
225	13,4	1,0	10,209	13	143	WPR710170225013*
250	14,8	1,0	12,372	13	143	WPR710170250013*
280	16,6	1,0	15,333	13	65	WPR710170280013*
315	18,7	1,2	19,566	13	65	WPR710170315013*
355	21,1	1,2	24,548	13	65	WPR710170355013*
400	23,7	1,2	30,715	13	26	WPR710170400013*
450	26,7	1,2	38,514	13	26	WPR710170450013*

**Material:** PE100 RC (resistant to cracks), PP peelable layer.

Underneath the protective layer is inserted a stainless steel thread for detecting the pipe.

**Reference standards:**

EN EN 12201, PAS 1075 Type 3

**Use:** in water under pressure networks, for alternative installation techniques (horizontal directional drilling, relining etc.).



### “WaterPRO” PE100RC pipe for potable water with protective PP layer

#### SDR11 PN16

Dext. [mm]	e <sub>n</sub> [mm]	g [mm]	Weight [kg/m]	L [m]		Code
75	6,8	0,8	1,629	100		WPR516110075100*
75	6,8	0,8	1,629	13	1352	WPR516110075013*
90	8,2	0,8	2,311	100		WPR516110090100*
90	8,2	0,8	2,311	13	871	WPR516110090013*
110	10,0	0,8	3,386	100		WPR516110110100*
110	10,0	0,8	3,386	13	559	WPR516110110013*
125	11,4	0,8	4,343	13	299	WPR516110125013*
140	12,7	0,8	5,383	13	260	WPR516110140013*
160	14,6	0,8	7,010	13	182	WPR516110160013*
180	16,4	1,0	8,915	13	143	WPR516110180013*
200	18,2	1,0	10,927	13	182	WPR516110200013*
225	20,5	1,0	13,760	13	143	WPR516110225013*
250	22,7	1,0	16,854	13	91	WPR516110250013*
280	25,4	1,0	21,024	13	65	WPR516110280013*
315	28,6	1,2	26,699	13	65	WPR516110315013*
355	32,2	1,2	33,719	13	26	WPR516110355013*
400	36,3	1,2	42,645	13	26	WPR516110400013*
450	40,9	1,2	53,842	13	26	WPR516110450013*

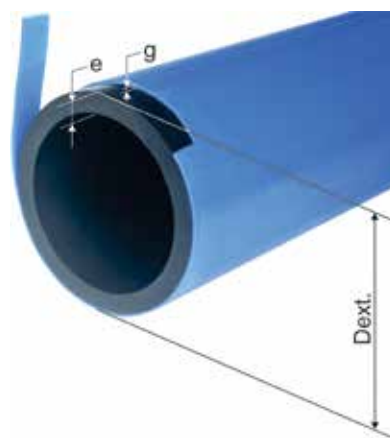

**Material:** PE100 RC (resistant to cracks), PP peelable layer.  
**Reference standards:** EN EN 12201, PAS 1075 Type 3  
**Use:** in water under pressure networks, for alternative installation techniques (horizontal directional drilling, relining etc.)

#### SDR17 PN10

Dext. [mm]	e <sub>n</sub> [mm]	g [mm]	Weight [kg/m]	L [m]		Code
75	4,5	0,8	1,171	100		WPR510170075100*
75	4,5	0,8	1,171	13	1352	WPR510170075013*
90	5,4	0,8	1,643	100		WPR510170090100*
90	5,4	0,8	1,643	13	871	WPR510170090013*
110	6,6	0,8	2,395	100		WPR510170110100*
110	6,6	0,8	2,395	13	559	WPR510170110013*
125	7,4	0,8	3,017	13	299	WPR510170125013*
140	8,3	0,8	3,748	13	260	WPR510170140013*
160	9,5	0,8	4,847	13	182	WPR510170160013*
180	10,7	1,0	6,194	13	143	WPR510170180013*
200	11,9	1,0	7,586	13	143	WPR510170200013*
225	13,4	1,0	9,524	13	143	WPR510170225013*
250	14,8	1,0	11,614	13	143	WPR510170250013*
280	16,6	1,0	14,486	13	65	WPR510170280013*
315	18,7	1,2	18,426	13	65	WPR510170315013*
355	21,1	1,2	23,265	13	65	WPR510170355013*
400	23,7	1,2	29,273	13	26	WPR510170400013*
450	26,7	1,2	36,892	13	26	WPR510170450013*

**Material:** PE100 RC (resistant to cracks), PP peelable layer.  
**Reference standards:** EN EN 12201, PAS 1075 Type 3  
**Use:** in water under pressure networks, for alternative installation techniques (horizontal directional drilling, relining etc.)





### “WaterPRO” PE100RC pipe for potable water with protective PP layer

#### SDR26 PN6

Dext. [mm]	e <sub>n</sub> [mm]	g [mm]	Weight [kg/m]	L [m]		Code
75	2,9	0,8	0,834	13	1352	WPR506260075013*
90	3,5	0,8	1,162	13	871	WPR506260090013*
110	4,2	0,8	1,652	13	559	WPR506260110013*
125	4,8	0,8	2,101	13	299	WPR506260125013*
140	5,4	0,8	2,605	13	260	WPR506260140013*
160	6,2	0,8	3,360	13	182	WPR506260160013*
180	6,9	1,0	4,268	13	143	WPR506260180013*
200	7,7	1,0	5,221	13	143	WPR506260200013*
225	8,6	1,0	6,483	13	143	WPR506260225013*
250	9,6	1,0	7,952	13	143	WPR506260250013*
280	10,7	1,0	9,832	13	65	WPR506260280013*
315	12,1	1,2	12,571	13	65	WPR506260315013*
355	13,6	1,2	15,767	13	65	WPR506260355013*
400	15,3	1,2	19,807	13	26	WPR506260400013*
450	17,2	1,2	24,850	13	26	WPR506260450013*

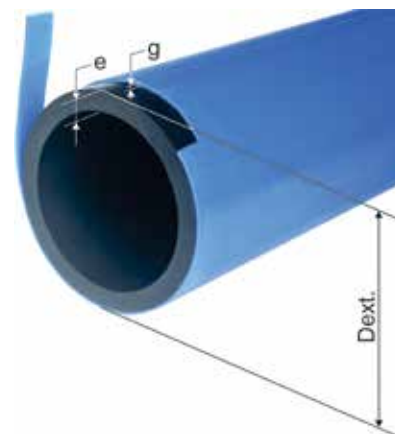

**Material:** PE100 RC (resistant to cracks), PP peelable layer.  
**Reference standards:** EN EN 12201, PAS 1075 Type 3  
**Use:** in water under pressure networks, for alternative installation techniques (horizontal directional drilling, relining etc.)

### “WaterPRO” PE100RC pipe for potable water with protective PP layer and metallic wire for detection

#### SDR11 PN16

Dext. [mm]	e <sub>n</sub> [mm]	g [mm]	Weight [kg/m]	L [m]		Code
75	6,8	0,8	1,822	100		WPR316110075100*
75	6,8	0,8	1,822	13	1352	WPR316110075013*
90	8,2	0,8	2,540	100		WPR316110090100*
90	8,2	0,8	2,540	13	871	WPR316110090013*
110	10,0	0,8	3,662	100		WPR316110110100*
110	10,0	0,8	3,662	13	559	WPR316110110013*
125	11,4	0,8	4,655	13	299	WPR316110125013*
140	12,7	0,8	5,731	13	260	WPR316110140013*
160	14,6	0,8	7,407	13	182	WPR316110160013*
180	16,4	1,0	9,466	13	143	WPR316110180013*
200	18,2	1,0	11,539	13	182	WPR316110200013*
225	20,5	1,0	14,445	13	143	WPR316110225013*
250	22,7	1,0	17,612	13	91	WPR316110250013*
280	25,4	1,0	21,873	13	65	WPR316110280013*
315	28,6	1,2	27,839	13	65	WPR316110315013*
355	32,2	1,2	35,002	13	26	WPR316110355013*
400	36,3	1,2	44,089	13	26	WPR316110400013*
450	40,9	1,2	55,464	13	26	WPR316110450013*

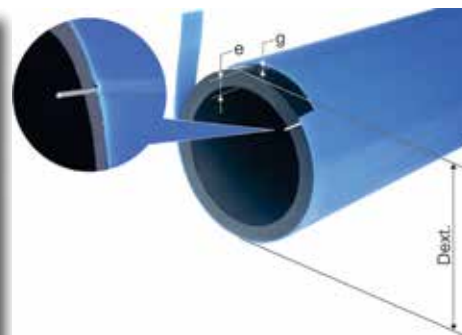

**Material:** PE100, PP peelable layer  
 Underneath the protective layer is inserted a stainless steel thread for detecting the pipe.  
**Reference standards:** EN 12201  
**Use:** water networks under pressure, installation in open trench without sand bed.



### “WaterPRO” PE100RC pipe for potable water with protective PP layer and metallic wire for detection

#### SDR13,6 PN12,5

Dext. [mm]	e <sub>n</sub> [mm]	g [mm]	Weight [kg/m]	L [m]		Code
75	5,6	0,8	1,588	13	1352	WPR312130075013*
90	6,7	0,8	2,189	13	871	WPR312130090013*
110	8,1	0,8	3,117	13	559	WPR312130110013*
125	9,2	0,8	3,938	13	299	WPR312130125013*
140	10,3	0,8	4,855	13	260	WPR312130140013*
160	11,8	0,8	6,237	13	182	WPR312130160013*
180	13,3	1,0	8,011	13	143	WPR312130180013*
200	14,7	1,0	9,713	13	143	WPR312130200013*
225	16,6	1,0	12,157	13	143	WPR312130225013*
250	18,4	1,0	14,809	13	143	WPR312130250013*
280	20,6	1,0	18,367	13	65	WPR312130280013*
315	23,2	1,2	23,402	13	65	WPR312130315013*
355	26,1	1,2	29,352	13	65	WPR312130355013*
400	29,4	1,2	36,889	13	26	WPR312130400013*
450	33,1	1,2	46,309	13	26	WPR312130450013*

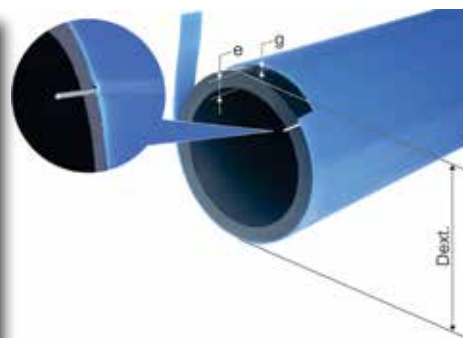

**Material:** PE100, PP peelable layer  
 Underneath the protective layer is inserted a stainless steel thread for detecting the pipe.  
**Reference standards:** EN 12201  
**Use:** water networks under pressure, installation in open trench without sand bed.

#### SDR17 PN10

Dext. [mm]	e <sub>n</sub> [mm]	g [mm]	Weight [kg/m]	L [m]		Code
75	4,5	0,8	1,365	100		WPR310170075100*
75	4,5	0,8	1,365	13	1352	WPR310170075013*
90	5,4	0,8	1,873	100		WPR310170090100*
90	5,4	0,8	1,873	13	871	WPR310170090013*
110	6,6	0,8	2,671	100		WPR310170110100*
110	6,6	0,8	2,671	13	559	WPR310170110013*
125	7,4	0,8	3,329	13	299	WPR310170125013*
140	8,3	0,8	4,097	13	260	WPR310170140013*
160	9,5	0,8	5,243	13	182	WPR310170160013*
180	10,7	1,0	6,745	13	143	WPR310170180013*
200	11,9	1,0	8,196	13	143	WPR310170200013*
225	13,4	1,0	10,209	13	143	WPR310170225013*
250	14,8	1,0	12,372	13	143	WPR310170250013*
280	16,6	1,0	15,333	13	65	WPR310170280013*
315	18,7	1,2	19,566	13	65	WPR310170315013*
355	21,1	1,2	24,548	13	65	WPR310170355013*
400	23,7	1,2	30,715	13	26	WPR310170400013*
450	26,7	1,2	38,514	13	26	WPR310170450013*

**Material:** PE100, PP peelable layer  
 Underneath the protective layer is inserted a stainless steel thread for detecting the pipe.  
**Reference standards:** EN 12201  
**Use:** water networks under pressure, installation in open trench without sand bed.



### “WaterPRO” PE100RC pipe for potable water with protective PP layer and metallic wire for detection

#### SDR21 PN8

Dext. [mm]	e <sub>n</sub> [mm]	g [mm]	Weight [kg/m]	L [m]		Code
75	3,6	0,8	1,177	13	1352	WPR308210075013*
90	4,3	0,8	1,597	13	871	WPR308210090013*
110	5,3	0,8	2,273	13	559	WPR308210110013*
125	6,0	0,8	2,841	13	299	WPR308210125013*
140	6,7	0,8	3,470	13	260	WPR308210140013*
160	7,7	0,8	4,439	13	182	WPR308210160013*
180	8,6	1,0	5,692	13	143	WPR308210180013*
200	9,6	1,0	6,914	13	143	WPR308210200013*
225	10,8	1,0	8,580	13	143	WPR308210225013*
250	11,9	1,0	10,351	13	143	WPR308210250013*
280	13,4	1,0	12,836	13	65	WPR308210280013*
315	15,0	1,2	16,317	13	65	WPR308210315013*
355	16,9	1,2	20,392	13	65	WPR308210355013*
400	19,1	1,2	25,586	13	26	WPR308210400013*
450	21,5	1,2	31,992	13	26	WPR308210450013*

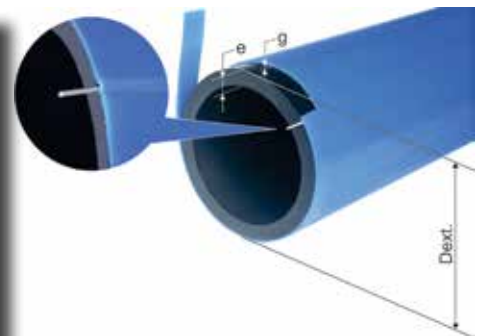

**Material:** PE100, PP peelable layer  
 Underneath the protective layer is inserted a stainless steel thread for detecting the pipe.  
**Reference standards:** EN 12201  
**Use:** water networks under pressure, installation in open trench without sand bed.

#### SDR26 PN6

Dext. [mm]	e <sub>n</sub> [mm]	g [mm]	Masa weight/масса [kg/m]	L [m]		Cod code/код
75	2,9	0,8	1,027	13	1352	WPR306260075013*
90	3,5	0,8	1,392	13	871	WPR306260090013*
110	4,2	0,8	1,928	13	559	WPR306260110013*
125	4,8	0,8	2,413	13	299	WPR306260125013*
140	5,4	0,8	2,953	13	260	WPR306260140013*
160	6,2	0,8	3,755	13	182	WPR306260160013*
180	6,9	1,0	4,819	13	143	WPR306260180013*
200	7,7	1,0	5,833	13	143	WPR306260200013*
225	8,6	1,0	7,168	13	143	WPR306260225013*
250	9,6	1,0	8,710	13	143	WPR306260250013*
280	10,7	1,0	10,681	13	65	WPR306260280013*
315	12,1	1,2	13,711	13	65	WPR306260315013*
355	13,6	1,2	17,050	13	65	WPR306260355013*
400	15,3	1,2	21,251	13	26	WPR306260400013*
450	17,2	1,2	26,471	13	26	WPR306260450013*

**Material:** PE100, PP peelable layer  
 Underneath the protective layer is inserted a stainless steel thread for detecting the pipe.  
**Reference standards:** EN 12201  
**Use:** water networks under pressure, installation in open trench without sand bed.



### “WaterPRO” PE100RC pipe for potable water with protective PP layer

#### SDR11 PN16

Dext. [mm]	e <sub>n</sub> [mm]	g [mm]	Weight [kg/m]	L [m]		Code
75	6,8	0,8	1,629	100		WPR116110075100*
75	6,8	0,8	1,629	13	1352	WPR116110075013*
90	8,2	0,8	2,311	100		WPR116110090100*
90	8,2	0,8	2,311	13	871	WPR116110090013*
110	10,0	0,8	3,386	100		WPR116110110100*
110	10,0	0,8	3,386	13	559	WPR116110110013*
125	11,4	0,8	4,343	13	299	WPR116110125013*
140	12,7	0,8	5,383	13	260	WPR116110140013*
160	14,6	0,8	7,010	13	182	WPR116110160013*
180	16,4	1,0	8,915	13	143	WPR116110180013*
200	18,2	1,0	10,927	13	182	WPR116110200013*
225	20,5	1,0	13,760	13	143	WPR116110225013*
250	22,7	1,0	16,854	13	91	WPR116110250013*
280	25,4	1,0	21,024	13	65	WPR116110280013*
315	28,6	1,2	26,699	13	65	WPR116110315013*
355	32,2	1,2	33,719	13	26	WPR116110355013*
400	36,3	1,2	42,645	13	26	WPR116110400013*
450	40,9	1,2	53,842	13	26	WPR116110450013*

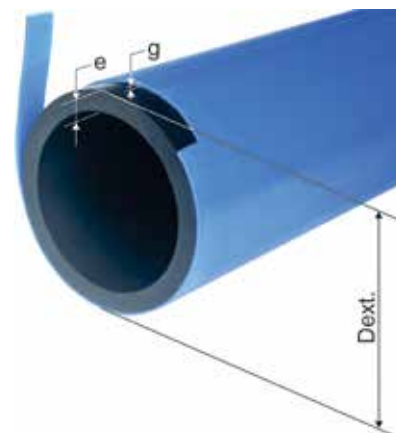

**Material:** PE100, PP peelable layer  
**Reference standards:** EN 12201.  
**Use:** water networks under pressure, installation in open trench without sand bed.

#### SDR13,6 PN12,5

Dext. [mm]	e <sub>n</sub> [mm]	g [mm]	Weight [kg/m]	L [m]		Code
75	5,6	0,8	1,394	100		WPR112130075100*
75	5,6	0,8	1,394	13	1352	WPR112130075013*
90	6,7	0,8	1,959	100		WPR112130090100*
90	6,7	0,8	1,959	13	871	WPR112130090013*
110	8,1	0,8	2,841	100		WPR112130110100*
110	8,1	0,8	2,841	13	559	WPR112130110013*
125	9,2	0,8	3,626	13	299	WPR112130125013*
140	10,3	0,8	4,506	13	260	WPR112130140013*
160	11,8	0,8	5,842	13	182	WPR112130160013*
180	13,3	1,0	7,460	13	143	WPR112130180013*
200	14,7	1,0	9,102	13	143	WPR112130200013*
225	16,6	1,0	11,472	13	143	WPR112130225013*
250	18,4	1,0	14,050	13	143	WPR112130250013*
280	20,6	1,0	17,517	13	65	WPR112130280013*
315	23,2	1,2	22,262	13	65	WPR112130315013*
355	26,1	1,2	28,069	13	65	WPR112130355013*
400	29,4	1,2	35,445	13	26	WPR112130400013*
450	33,1	1,2	44,688	13	26	WPR112130450013*

**Material:** PE100, PP peelable layer  
**Reference standards:** EN 12201.  
**Use:** water networks under pressure, installation in open trench without sand bed.





### “WaterPRO” PE100RC pipe for potable water with protective PP layer

#### SDR17 PN10

Dext. [mm]	e <sub>n</sub> [mm]	g [mm]	Weight [kg/m]	L [m]		Code
75	4,5	0,8	1,171	100		WPR110170075100*
75	4,5	0,8	1,171	13	1352	WPR110170075013*
90	5,4	0,8	1,643	100		WPR110170090100*
90	5,4	0,8	1,643	13	871	WPR110170090013*
110	6,6	0,8	2,395	100		WPR110170110100*
110	6,6	0,8	2,395	13	559	WPR110170110013*
125	7,4	0,8	3,017	13	299	WPR110170125013*
140	8,3	0,8	3,748	13	260	WPR110170140013*
160	9,5	0,8	4,847	13	182	WPR110170160013*
180	10,7	1,0	6,194	13	143	WPR110170180013*
200	11,9	1,0	7,586	13	143	WPR110170200013*
225	13,4	1,0	9,524	13	143	WPR110170225013*
250	14,8	1,0	11,614	13	143	WPR110170250013*
280	16,6	1,0	14,486	13	65	WPR110170280013*
315	18,7	1,2	18,426	13	65	WPR110170315013*
355	21,1	1,2	23,265	13	65	WPR110170355013*
400	23,7	1,2	29,273	13	26	WPR110170400013*
450	26,7	1,2	36,892	13	26	WPR110170450013*

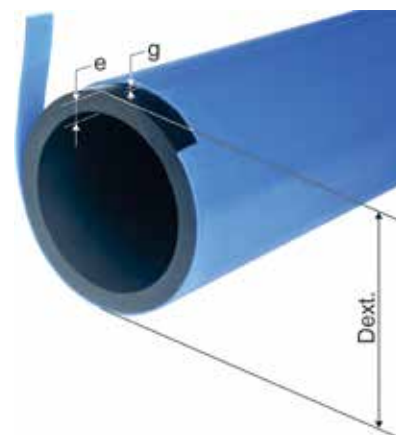

**Material:** PE100, PP peelable layer  
**Reference standards:** EN 12201.  
**Use:** water networks under pressure, installation in open trench without sand bed.

#### SDR21 PN8

Dext. [mm]	e <sub>n</sub> [mm]	g [mm]	Weight [kg/m]	L [m]		Code
75	3,6	0,8	0,983	100	1352	WPR108210075100*
75	3,6	0,8	0,983	13	1352	WPR108210075013*
90	4,3	0,8	1,367	13	871	WPR108210090013*
110	5,3	0,8	1,997	13	559	WPR108210110013*
125	6,0	0,8	2,529	13	299	WPR108210125013*
140	6,7	0,8	3,124	13	260	WPR108210140013*
160	7,7	0,8	4,044	13	182	WPR108210160013*
180	8,6	1,0	5,141	13	143	WPR108210180013*
200	9,6	1,0	6,305	13	143	WPR108210200013*
225	10,8	1,0	7,895	13	143	WPR108210225013*
250	11,9	1,0	9,592	13	143	WPR108210250013*
280	13,4	1,0	11,989	13	65	WPR108210280013*
315	15,0	1,2	15,177	13	65	WPR108210315013*
355	16,9	1,2	19,109	13	65	WPR108210355013*
400	19,1	1,2	24,144	13	26	WPR108210400013*
450	21,5	1,2	30,371	13	26	WPR108210450013*

**Material:** PE100, PP peelable layer  
**Reference standards:** EN 12201.  
**Use:** water networks under pressure, installation in open trench without sand bed.



### “WaterPRO” PE100RC pipe for potable water with protective PP layer

#### SDR26 PN6

Dext. [mm]	e <sub>n</sub> [mm]	g [mm]	Weight [kg/m]	L [m]		Code
75	2,9	0,8	0,834	13	1352	WPR106260075013*
90	3,5	0,8	1,162	13	871	WPR106260090013*
110	4,2	0,8	1,652	13	559	WPR106260110013*
125	4,8	0,8	2,101	13	299	WPR106260125013*
140	5,4	0,8	2,605	13	260	WPR106260140013*
160	6,2	0,8	3,360	13	182	WPR106260160013*
180	6,9	1,0	4,268	13	143	WPR106260180013*
200	7,7	1,0	5,221	13	143	WPR106260200013*
225	8,6	1,0	6,483	13	143	WPR106260225013*
250	9,6	1,0	7,952	13	143	WPR106260250013*
280	10,7	1,0	9,832	13	65	WPR106260280013*
315	12,1	1,2	12,571	13	65	WPR106260315013*
355	13,6	1,2	15,767	13	65	WPR106260355013*
400	15,3	1,2	19,807	13	26	WPR106260400013*
450	17,2	1,2	24,850	13	26	WPR106260450013*

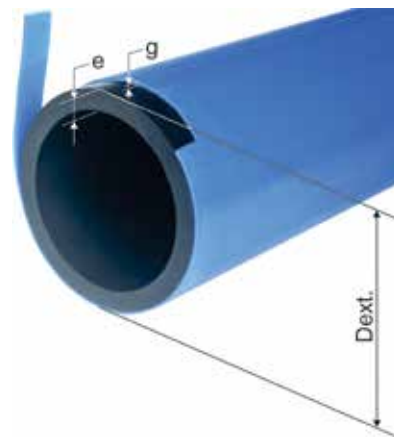

**Material:** PE100, PP peelable layer  
**Reference standards:** EN 12201.  
**Use:** water networks under pressure, installation in open trench without sand bed.



### PE100 RC pipe for potable water

#### SDR11 PN16 (C=1,25)

Dext. [inch] [mm]	e <sub>n</sub> [mm]	Weight [kg/m]	L [m]		Code
3/4"	25	2,3	200	1800	28160250200*
1"	32	3,0	200	1400	28160320200*
1"	32	3,0	100		28160320100*
1"1/4"	40	3,7	100	900	28160400100*
1"1/2"	50	4,6	100	800	28160500100*
2"	63	5,8	100		28160630100*
2"1/2"	75	6,8	100		28160750100*
2"1/2"	75	6,8	13		28160750013*
3"	90	8,2	100		28160900100*
3"	90	8,2	13		28160900013*
4"	110	10,0	100		28161100100*
4"	110	10,0	13		28161100113*
4"1/2"	125	11,4	13	299	28161250013*
5"	140	12,7	13	260	28161400013*
6"	160	14,6	13	182	28161600013*
6"	180	16,4	13	143	28161800013*
8"	200	18,2	13	182	28162000013*
8"	225	20,5	13	143	28162250013*
10"	250	22,7	13	91	28162500013*
11"	280	25,4	13	65	28162800013*
13"	315	28,6	13	65	28163150013*
14"	355	32,2	13	26	28163550013*
16"	400	36,3	13	26	28164000013*
18"	450	40,9	13	26	28164500013*
20"	500	45,4	13	26	28165000013*
22"	560	50,8	13	26	28165600013*
25"	630	57,2	13	26	28166300013*
	710	64,5	13		28167100013*
	800	72,6	13		28168000013*
	900	81,7	13		28169000013*
	1000	90,8	13		28169100013*

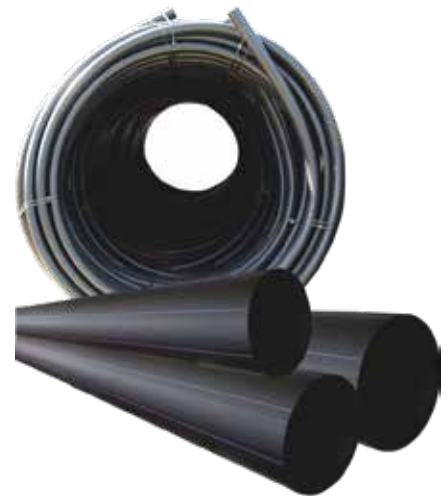

**Material:** PE100 RC (resistant to crack)  
**Reference standards:** EN 12201, PAS 1075 Type 1  
**Use:** water networks under pressure, for alternative installation techniques (horizontal directional drilling, relining etc.), C=1,6

#### SDR13,6, PN12,5 (C=1,25)

Dext. [inch] [mm]	e <sub>n</sub> [mm]	Weight [kg/m]	L [m]		Code
110	8,1	2,577	100		28121100100*
110	8,1	2,577	13		28121100013*
125	9,2	3,326	13		28121250013*
140	10,3	4,171	13		28121400013*
710	52,2	107,184	13		28127100013*
800	58,8	136,043	13		28128000013*
900	66,1	172,299	13		28129000013*
1000	73,4	209,901	13		28129100013*
1200	88,2	306,097	13		28129120013*

**Material:** PE100 RC (resistant to crack)  
**Reference standards:** EN 12201, PAS 1075 Type 1  
**Use:** water networks under pressure, for alternative installation techniques (horizontal directional drilling, relining etc.), C=1,6



### PE100 RC pipe for potable water

SDR17 PN10 (C=1,25);

Dext. [inch] [mm]	e <sub>n</sub> [mm]	Weight [kg/m]	L [m]		Code
1/2"	20	2,0	0,113	200	28100200200*
3/4"	25	2,0	0,144	200	28100250200*
1"	32	2,0	0,188	200 1400	28100320200*
1"1/4	40	2,4	0,282	100 900	28100400100*
1"1/2	50	3,0	0,441	100 800	28100500100*
2"	63	3,8	0,703	100	28100630100*
2"1/2	75	4,5	0,991	100	28100750100*
2"1/2	75	4,5	0,991	13	28100750013*
3"	90	5,4	1,427	100	28100900100*
3"	90	5,4	1,427	13	28100900013*
4"	110	6,6	2,131	100	28101100100*
4"	110	6,6	2,131	13	28101100113*
4"1/2	125	7,4	2,717	13 299	28101250013*
5"	140	8,3	3,413	13 260	28101400013*
6"	160	9,5	4,463	13 182	28101600013*
6"	180	10,7	5,655	13 143	28101800013*
8"	200	11,9	6,988	13 143	28102000013*
8"	225	13,4	8,851	13 143	28102250013*
10"	250	14,8	10,866	13 143	28102500013*
11"	280	16,6	13,649	13 65	28102800013*
13"	315	18,7	17,296	13 65	28103150013*
14"	355	21,1	21,992	13 65	28103550013*
16"	400	23,7	27,839	13 26	28104000013*
18"	450	26,7	35,280	13 26	28104500013*
20"	500	29,7	43,601	13 26	28105000013*
22"	560	33,2	54,595	13 26	28105600013*
25"	630	37,4	69,183	13 26	28106300013*
	710	42,1	87,773	13	28107100013*
	800	47,4	111,354	13	28108000013*
	900	53,3	140,871	13	28109000013*
	1000	59,3	174,128	13	28109100013*
	1200	71,1	250,547	13	28109120013*

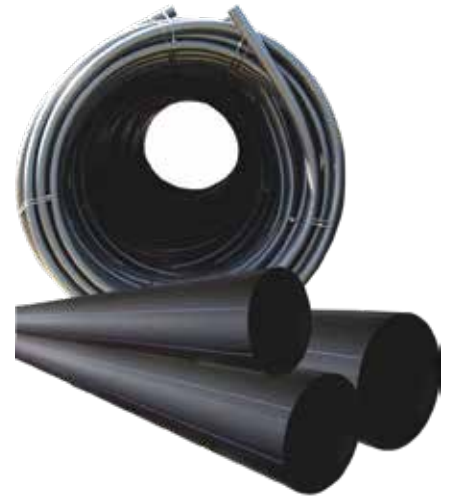

**Material:** PE100 RC (resistant to crack)  
**Reference standards:** EN 12201, PAS 1075 Type 1  
**Use:** water networks under pressure, for alternative installation techniques (horizontal directional drilling, relining etc.), C=1,6





### PE100 RC pipe for potable water

#### SDR 21, PN8 (C=1,25)

Dext. [mm]	e <sub>n</sub> [mm]	Weight [kg/m]	L [m]		Code
125	6,0	2,229	13	299	28081250013*
140	6,7	2,788	13	260	28081400013*
160	7,7	3,661	13	182	28081600013*
180	8,6	4,602	13	143	28081800013*
200	9,6	5,706	13	143	28082000013*
225	10,8	7,222	13	143	28082250013*
250	11,9	8,845	13	143	28082500013*
280	13,4	11,152	13	65	28082800013*
315	15,0	14,047	13	65	28083150013*
355	16,9	17,836	13	65	28083550013*
400	19,1	22,710	13	26	28084000013*
450	21,5	28,758	13	26	28084500013*
500	23,9	35,519	13	26	28085000013*
560	26,7	44,448	13	26	28085600013*
630	30,0	56,187	13	26	28086300013*
710	33,9	71,544	13		28087100013*
800	38,1	90,612	13		28088000013*
900	42,9	114,777	13		28089000013*
1000	47,7	141,793	13		28089100013*
1200	57,2	204,047	13		28089120013*

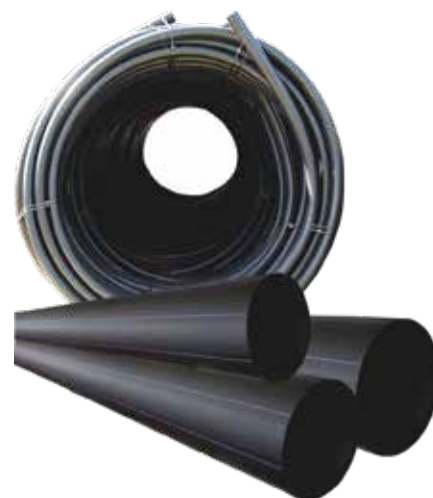

**Material:** PE100 RC (resistant to crack)  
**Reference standards:** EN 12201, PAS 1075 Type 1  
**Use:** water networks under pressure, for alternative installation techniques (horizontal directional drilling, relining etc.), C=1,6

#### SDR26 PN6 (C=1,25);

Dext. [inch] [mm]	e <sub>n</sub> [mm]	Weight [kg/m]	L [m]		Code
2"1/2 75	2,9	0,653	13	1352	28060750013*
3" 90	3,5	0,946	13	871	28060900013*
4" 110	4,2	1,388	13	559	28061100013*
4"1/2 125	4,8	1,801	13	299	28061250013*
5" 140	5,4	2,269	13	260	28061400013*
6" 160	6,2	2,977	13	182	28061600013*
6" 180	6,9	3,729	13	143	28061800013*
8" 200	7,7	4,623	13	143	28062000013*
8" 225	8,6	5,810	13	143	28062250013*
10" 250	9,6	7,204	13	143	28062500013*
11" 280	10,7	8,995	13	65	28062800013*
13" 315	12,1	11,441	13	65	28063150013*
14" 355	13,6	14,494	13	65	28063550013*
16" 400	15,3	18,373	13	26	28064000013*
18" 450	17,2	23,237	13	26	28064500013*
20" 500	19,1	28,672	13	26	28065000013*
22" 560	21,4	35,980	13	26	28065600013*
25" 630	24,1	45,581	13	26	28066300013*
710	27,2	57,973	13		28067100013*
800	30,6	73,492	13		28068000013*
900	34,4	92,948	13		28069000013*
1000	38,2	114,687	13		28069100013*
1200	45,9	165,356	13		28069120013*

**Material:** PE100 RC (resistant to crack)  
**Reference standards:** EN 12201, PAS 1075 Type 1  
**Use:** water networks under pressure, for alternative installation techniques (horizontal directional drilling, relining etc.), C=1,6



### PE100 pipe for potable water

#### SDR7,4 PN25

Dext.		e <sub>n</sub>	Weight	L		Code
[inch]	[mm]	[mm]	[kg/m]	[m]		
1"1/2	50	6,9	0,929	100	800	24250500100*
2"1/2	75	10,3	2,081	13		24250750013*
3"	90	12,3	2,984	100		24250900100*
3"	90	12,3	2,984	50		24250900050*
1"1/2	50	6,9	7,240	13	260	24251400013*
6"	160	21,9	9,441	13	182	24251600013*
6"	180	24,6	11,933	13	143	24251800013*
10"	250	34,2	23,038	13	143	24252500013*
11"	280	38,3	28,897	13	65	24252800013*



#### SDR9 PN20

Dext.		e <sub>n</sub>	Weight	L		Code
[inch]	[mm]	[mm]	[kg/m]	[m]		
2"1/2	75	8,4	1,747	100		24200750100*
3"	90	10,0	2,520	100		24200900100*
3"	90	10,0	2,520	50		24200900050*
4"	110	12,3	3,752	13		24201100013*
4"1/2	125	14,0	4,851	13	299	24201250013*
6"	160	17,9	7,940	13	182	24201600013*
6"	180	20,1	10,033	13	143	24201800013*
8"	200	22,4	12,419	13	143	24202000013*
10"	250	27,9	19,343	13	143	24202500013*
11"	280	31,3	24,299	13	65	24202800013*
13"	315	35,2	30,744	13	65	24203150013*
14"	355	39,7	39,074	13	65	24203550013*
20"	500	55,8	77,371	13	26	24205000013*
22"	560	62,5	97,059	13	26	24205600013*

**Material:** PE100

**Reference standards:** ISO 4427, EN 12201, DIN 8074/8075

**Use:** water networks under pressure, installation in open trench with sandbed



### PE100 pipe for potable water

#### SDR11 PN16

Dext. [inch] [mm]		e <sub>n</sub> [mm]	Weight [kg/m]	L [m]		Code
1/2"	20	2,0	0,113	200		24160200200*
3/4"	25	2,3	0,163	200		24160250200
3/4"	25	2,3	0,163	100		24160250100*
1"	32	3,0	0,272	200		24160320200
1"	32	3,0	0,272	100		24160320100*
1"1/4	40	3,7	0,420	100	900	24160400100
1"1/2	50	4,6	0,652	100	800	24160500100
2"	63	5,8	1,036	100		24160630100
2"1/2	75	6,8	1,448	100		24160750100
3"	90	8,2	2,094	100		24160900100
3"	90	8,2	2,094	13		24160900013*
4"	110	10,0	3,122	100		24161100100
4"	110	10,0	3,122	13		24161100013
4"1/2	125	11,4	4,043	13	299	24161250013
5"	140	12,7	5,047	13	260	24161400013*
6"	160	14,6	6,627	13	182	24161600013
6"	180	16,4	8,376	13	143	24161800013*
8"	200	18,2	10,329	13	182	24162000013*
8"	225	20,5	13,087	13	143	24162250013*
10"	250	22,7	16,107	13	91	24162500013*
11"	280	25,4	20,187	13	65	24162800013*
13"	315	28,6	25,569	13	65	24163150013*
14"	355	32,2	32,446	13	26	24163550013*
16"	400	36,3	41,211	13	26	24164000013*
18"	450	40,9	52,230	13	26	24164500013*
20"	500	45,4	64,425	13	26	24165000013*
22"	560	50,8	80,745	13	26	24165600013*
25"	630	57,2	102,274	13	26	24166300013*
	710	64,5	129,963	13		24117100013*
	800	72,6	164,844	13		24118000013*
	900	81,7	208,688	13		24119000013*
	1000	90,8	257,697	13		24119100013*



**Material:** PE100

**Reference standards:** ISO 4427, EN 12201, DIN 8074/8075

**Use:** water networks under pressure, installation in open trench with sandbed



### PE100 pipe for potable water

#### SDR13,6 PN12,5

Dext. [inch] [mm]	e <sub>n</sub> [mm]	Weight [kg/m]	L [m]		Code	
4"1/2	125	9,2	3,326	13	299	24121250013*
5"	140	10,3	4,171	13	260	24121400013*
6"	160	11,8	5,459	13	182	24121600013*
6"	180	13,3	6,921	13	143	24121800013*
8"	200	14,7	8,503	13	143	24122000013*
8"	225	16,6	10,799	13	143	24122250013*
10"	250	18,4	13,303	13	143	24122500013*
11"	280	20,6	16,681	13	65	24122800013*
13"	315	23,2	21,132	13	65	24123150013*
14"	355	26,1	26,796	13	65	24123550013*
16"	400	29,4	34,011	13	26	24124000013*
18"	450	33,1	43,075	13	26	24124500013*
20"	500	36,8	53,209	13	26	24125000013*
22"	560	41,2	66,721	13	26	24125600013*
25"	630	46,3	84,360	13	26	24126300013*
	710	52,2	107,184	13		24137100013*
	800	58,8	136,043	13		24138000013*
	900	66,1	172,299	13		24139000013*
	1000	73,4	209,901	13		24139100013*
	1200	88,2	306,097	13		24139120013*



**Material:** PE100

**Reference standards:** ISO 4427, EN 12201, DIN 8074/8075

**Use:** water networks under pressure, installation in open trench with sandbed



### PE100 pipe for potable water

#### SDR17 PN10

Dext.		e <sub>n</sub>	Weight	L		Code
[inch]	[mm]	[mm]	[kg/m]	[m]		
1/2"	20	2,0	0,113	200	2200	24100200200
1/2"	20	2,0	0,113	100		24100200100
3/4"	25	2,0	0,144	200	1800	24100250200
3/4"	25	2,0	0,144	100		24100250100
1"	32	2,0	0,188	200	1400	24100320200
1"	32	2,0	0,188	100		24100320100
1"1/4	40	2,4	0,282	100	900	24100400100
1"1/2	50	3,0	0,441	100	800	24100500100
2"	63	3,8	0,703	100		24100630100
2"1/2	75	4,5	0,991	100		24100750100
2"1/2	75	4,5	0,991	13		24100750013
2"1/2	75	4,5	0,991	6		24100750006*
3"	90	5,4	1,427	100		24100900100
3"	90	5,4	1,427	13		24100900013
3"	90	5,4	1,427	6		24100900006*
4"	110	6,6	2,131	100		24101100100
4"	110	6,6	2,131	13		24101100013
4"	110	6,6	2,131	6		24101100006*
4"1/2	125	7,4	2,717	100		24101250100
4"1/2	125	7,4	2,717	13		24101250013
4"1/2	125	7,4	2,717	6		24101250006*
5"	140	8,3	3,413	13	260	24101400013
5"	140	8,3	3,413	6		24101400006*
6"	160	9,5	4,463	13	182	24101600013
6"	160	9,5	4,463	6		24101600006*
6"	180	10,7	5,655	13	143	24101800013
6"	180	10,7	5,655	6		24101800006*
8"	200	11,9	6,988	13	143	24102000013
8"	200	11,9	6,988	6		24102000006*
8"	225	13,4	8,851	13	143	24102250013
8"	225	13,4	8,851	6		24102250006*
10"	250	14,8	10,866	13	143	24102500013
11"	280	16,6	13,649	13	65	24102800013
11"	280	16,6	13,649	6		24102800006*
13"	315	18,7	17,296	13	65	24103150013
13"	315	18,7	17,296	6		24103150006*
14"	355	21,1	21,992	13	65	24103550013*
16"	400	23,7	27,839	13	26	24104000013*
18"	450	26,7	35,280	13	26	24104500013*
20"	500	29,7	43,601	13	26	24105000013*
22"	560	33,2	54,595	13	26	24105600013*
25"	630	37,4	69,183	13	26	24106300013*
	710	42,1	87,773	13		24177100013*
	800	47,4	111,354	13		24178000013*
	900	53,3	140,871	13		24179000013*
	1000	59,3	174,128	13		24179100013*
	1200	71,1	250,547	13		24179120013*



**Material:** PE100

**Reference standards:** ISO 4427, EN 12201, DIN 8074/8075

**Use:** water networks under pressure, installation in open trench with sand bed.



### PE100 pipe for potable water

#### SDR21 PN8

Dext. [inch] [mm]	e <sub>n</sub> [mm]	Weight [kg/m]	L [m]		Code
1" 1/2	50	2,4	100	800	24080500100*
2"	63	3,0	100		24080630100*
2"1/2	75	3,6	100		24080750100
2"1/2	75	3,6	13	1352	24080750013*
3"	90	4,3	100		24080900100*
3"	90	4,3	13		24080900013*
4"	110	5,3	13	559	24081100013*
4"1/2	125	6,0	13	299	24081250013*
5"	140	6,7	13	260	24081400013*
6"	160	7,7	13	182	24081600013*
6"	180	8,6	13	143	24081800013*
8"	200	9,6	13	143	24082000013*
8"	225	10,8	13	143	24082250013*
10"	250	11,9	13	143	24082500013*
11"	280	13,4	13	65	24082800013*
13"	315	15,0	13	65	24083150013*
14"	355	16,9	13	65	24083550013*
16"	400	19,1	13	26	24084000013*
18"	450	21,5	13	26	24084500013*
20"	500	23,9	13	26	24085000013*
22"	560	26,7	13	26	24085600013*
25"	630	30,0	13	26	24086300013*
	710	33,9	13		24217100013*
	800	38,1	13		24218000013*
	900	42,9	13		24219000013*
	1000	47,7	13		24219100013*
	1200	57,2	13		24219120013*



**Material:** PE100

**Reference standards:** ISO 4427, EN 12201, DIN 8074/8075

**Use:** water networks under pressure, installation in open trench with sand bed.



### PE100 pipe for potable water

#### SDR26 PN6

Dext. [inch] [mm]	e <sub>n</sub> [mm]	Weight [kg/m]	L [m]		Code
2"1/2	75	2,9	13	1352	24060750013*
3"	90	3,5	13	871	24060900013
4"	110	4,2	13	559	24061100013
4"1/2	125	4,8	13	299	24061250013*
5"	140	5,4	13	260	24061400013*
6"	160	6,2	13	182	24061600013
6"	180	6,9	13	143	24061800013*
8"	200	7,7	13	143	24062000013*
8"	225	8,6	13	143	24062250013*
10"	250	9,6	13	143	24062500013*
11"	280	10,7	13	65	24062800013*
13"	315	12,1	13	65	24063150013*
14"	355	13,6	13	65	24063550013*
16"	400	15,3	13	26	24064000013*
18"	450	17,2	13	26	24064500013*
20"	500	19,1	13	26	24065000013*
22"	560	21,4	13	26	24065600013*
25"	630	24,1	13	26	24066300013*
	710	27,2	13		24267100013*
	800	30,6	13		24268000013*
	900	34,4	13		24269000013*
	1000	38,2	13		24269100013*
	1200	45,9	13		24269120013*



**Material:** PE100

**Reference standards:** ISO 4427, EN 12201, DIN 8074/8075

**Use:** water networks under pressure, installation in open trench with sand bed.

#### SDR27,6 PN6

Dext. [inch] [mm]	e <sub>n</sub> [mm]	Weight [kg/m]	L [m]		Code
3"	90	3,3	13	871	24060900113*
4"	110	4,0	13	559	24061100113*
4"1/2	125	4,6	13	299	24061250113*
5"	140	5,1	13	260	24061400113*
6"	160	5,8	13	182	24061600113*
6"	180	6,6	13	143	24061800113*
8"	200	7,3	13	143	24062000113*
8"	225	8,2	13	143	24062250113*
10"	250	9,1	13	143	24062500113*
11"	280	10,2	13	65	24062800113*
13"	315	11,4	13	65	24063150113*
14"	355	12,9	13	65	24063550113*
16"	400	14,5	13	26	24064000113*
18"	450	16,3	13	26	24064500113*
20"	500	18,1	13	26	24065000113*
22"	560	20,3	13	26	24065600113*
25"	630	22,8	13	26	24066300113*

**Material:** PE100

**Reference standards:** Company's Technical Standard

**Use:** water networks under pressure, installation in open trench with sandbed



**PIPES FOR LARGE AREA IRRIGATION**

“AgriProECO” pipes with PP protective coverage are intended for high pressure water supply of irrigation systems and could be mounted in an open ditch, without the need of a bed of sand.

Upon installation, the excavated earth can be used to fill the ditch, if it can be compacted. It should not contain stones or other residues with sharp or blunt edges or corners. The ground must sustain the pipe evenly over the entire circumference.

**Material:**

- PE100 pipe
- PP outside protective layer

$e_n$  - wall thickness without protection layer

$g$  - minimum thickness of protection layer

**PE100 irrigation pipe “AgriProECO” with protective PP layer**

**SDR26 PN6 (20°C)**

D ext [mm]	$e_n$ [mm]	g [mm]	Masa [kg/m]	L [m]		Code
75	2,9	0,8	0,834	13	1352	APR106260075013*
90	3,5	0,8	1,162	13	871	APR106260090013*
110	4,2	0,8	1,652	13	559	APR106260110013*
125	4,8	0,8	2,101	13	299	APR106260125013*
140	5,4	0,8	2,605	13	260	APR106260140013*
160	6,2	0,8	3,360	13	182	APR106260160013*
180	6,9	1,0	4,268	13	143	APR106260180013*
200	7,7	1,0	5,221	13	143	APR106260200013*
225	8,6	1,0	6,483	13	143	APR106260225013*
250	9,6	1,0	7,952	13	143	APR106260250013*
280	10,7	1,0	9,832	13	65	APR106260280013*
315	12,1	1,2	12,571	13	65	APR106260315013*
355	13,6	1,2	15,767	13	65	APR106260355013*
400	15,3	1,2	19,807	13	26	APR106260400013*
450	17,2	1,2	24,850	13	26	APR106260450013*
500	19,1	1,5	30,912	13	26	APR106260500013*
560	21,4	1,5	38,487	13	26	APR106260560013*
630	24,1	1,5	45,581	13	26	APR106260630013*



**Material:** PE100, PP peelable layer

**Reference standards:** Company's Technical Standard STF24

**Use:** water networks under pressure, installation in open trench without sand bed.



**PE100 irrigation pipe "AgriProECO" with protective PP layer**
**SDR21 PN8 (20°C)**

D ext [mm]	e <sub>n</sub> [mm]	g [mm]	Masa [kg/m]	L [m]		Code
75	3,6	0,8	0,983	13	1352	APR108210075013*
90	4,3	0,8	1,367	13	871	APR108210090013*
110	5,3	0,8	1,997	13	559	APR108210110013*
125	6,0	0,8	2,529	13	299	APR108210125013*
140	6,7	0,8	3,124	13	260	APR108210140013*
160	7,7	0,8	4,044	13	182	APR108210160013*
180	8,6	1,0	5,141	13	143	APR108210180013*
200	9,6	1,0	6,305	13	143	APR108210200013*
225	10,8	1,0	7,895	13	143	APR108210225013*
250	11,9	1,0	9,592	13	143	APR108210250013*
280	13,4	1,0	11,989	13	65	APR108210280013*
315	15,0	1,2	15,177	13	65	APR108210315013*
355	16,9	1,2	19,109	13	65	APR108210355013*
400	19,1	1,2	24,144	13	26	APR108210400013*
450	21,5	1,2	30,371	13	26	APR108210450013*
500	23,9	1,5	37,760	13	26	APR108210500013*
560	26,7	1,5	46,956	13	26	APR108210560013*
630	30,0	1,5	59,008	13	26	APR108210630013*



**Material:** PE100, PP peelable layer

**Reference standards:** Company's Technical Standard STF24

**Use:** water networks under pressure, installation in open trench without sand bed.

**SDR17 PN10 (20°C)**

D ext [mm]	e <sub>n</sub> [mm]	g [mm]	Masa [kg/m]	L [m]		Code
75	4,5	0,8	1,171	13	1352	APR110170075013*
75	4,5	0,8	1,171	100		APR110170075100*
90	5,4	0,8	1,643	13	871	APR110170090013*
90	5,4	0,8	1,643	100		APR110170090100*
110	6,6	0,8	2,395	13	559	APR110170110013*
110	6,6	0,8	2,395	100		APR110170110100*
125	7,4	0,8	3,017	13	299	APR110170125001*
140	8,3	0,8	3,748	13	260	APR110170140013*
160	9,5	0,8	4,847	13	182	APR110170160013*
180	10,7	1,0	6,194	13	143	APR110170180013*
200	11,9	1,0	7,586	13	143	APR110170200013*
225	13,4	1,0	9,524	13	143	APR110170225013*
250	14,8	1,0	11,614	13	143	APR110170250013*
280	16,6	1,0	14,486	13	65	APR110170280013*
315	18,7	1,2	18,426	13	65	APR110170315013*
355	21,1	1,2	23,265	13	65	APR110170355013*
400	23,7	1,2	29,273	13	26	APR110170400013*
450	26,7	1,2	36,892	13	26	APR110170450013*
500	29,7	1,5	45,842	13	26	APR110170500013*
560	33,2	1,5	57,103	13	26	APR110170560013*
630	37,4	1,5	72,004	13	26	APR110170630013*



### PE100 irrigation pipe "AgriProECO" with protective PP layer

#### SDR13,6 PN12,5 (20°C)

D ext [mm]	e <sub>n</sub> [mm]	g [mm]	Masa [kg/m]	L [m]		Code
75	5,6	0,8	1,394	13	1352	APR112130075013*
75	5,6	0,8	1,394	100		APR112130075100*
90	6,7	0,8	1,959	13	871	APR112130090013*
90	6,7	0,8	1,959	100		APR112130090100*
110	8,1	0,8	2,841	13	559	APR112130110013*
110	8,1	0,8	2,841	100		APR112130110100*
125	9,2	0,8	3,626	13	299	APR112130125013*
140	10,3	0,8	4,506	13	260	APR112130140013*
160	11,8	0,8	5,842	13	182	APR112130160013*
180	13,3	1,0	7,460	13	143	APR112130180013*
200	14,7	1,0	9,102	13	143	APR112130200013*
225	16,6	1,0	11,472	13	143	APR112130225013*
250	18,4	1,0	14,050	13	143	APR112130250013*
280	20,6	1,0	17,517	13	65	APR112130280013*
315	23,2	1,2	22,262	13	65	APR112130315013*
355	26,1	1,2	28,069	13	65	APR112130355013*
400	29,4	1,2	35,445	13	26	APR112130400013*
450	33,1	1,2	44,688	13	26	APR112130450013*
500	36,8	1,5	55,449	13	26	APR112130500013*
560	41,2	1,5	69,229	13	26	APR112130560013*
630	46,3	1,5	87,181	13	26	APR112130630013*

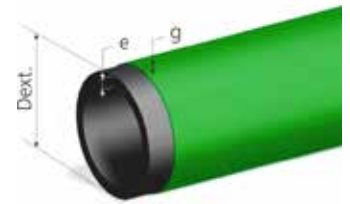

**Material:** PE100, PP peelable layer

**Reference standards:** Company's Technical Standard STF24

**Use:** water networks under pressure, installation in open trench without sand bed.

#### SDR11 PN16 (20°C)

D ext [mm]	e <sub>n</sub> [mm]	g [mm]	Masa [kg/m]	L [m]		Code
75	6,8	0,8	1,629	13	1352	APR116110075013*
75	6,8	0,8	1,629	100		APR116110075100*
90	8,2	0,8	2,311	13	871	APR116110090013*
90	8,2	0,8	2,311	100		APR116110090100*
110	10,0	0,8	3,386	13	559	APR116110110013*
110	10,0	0,8	3,386	100		APR116110110100*
125	11,4	0,8	4,343	13	299	APR116110125013*
140	12,7	0,8	5,383	13	260	APR116110140013*
160	14,6	0,8	7,010	13	182	APR116110160013*
180	16,4	1,0	8,915	13	143	APR116110180013*
200	18,2	1,0	10,927	13	143	APR116110200013*
225	20,5	1,0	13,760	13	143	APR116110225013*
250	22,7	1,0	16,854	13	143	APR116110250013*
280	25,4	1,0	21,024	13	65	APR116110280013*
315	28,6	1,2	26,699	13	65	APR116110315013*
355	32,2	1,2	33,719	13	65	APR116110355013*
400	36,3	1,2	42,645	13	26	APR116110400013*
450	40,9	1,2	53,842	13	26	APR116110450013*
500	45,4	1,5	66,665	13	26	APR116110500013*
560	50,8	1,5	83,254	13	26	APR116110560013*
630	57,2	1,5	105,095	13	26	APR116110630013*





28 Preciziei Bvd., 6<sup>th</sup> district, Bucharest, Romania

☎ +4 021 317 38 00  
office@valrom.ro  
www.valrom.ro