

Connected Home Radiator Valve Actuator ZigBee, wireless

SSA911.01ZB



Wireless radiator valve actuator, works with SIEMENS Connected Home

- RF-controlled actuator communication based on ZigBee protocol (2.4 GHz, bidirectional)
- Connection and operation with Connected Home Hub and Receiver
- Battery-powered by commercially available 1.5 V AA batteries
- Valve thread connection M30x1.5 mm
- Nominal stroke 5 mm
- Valve positioning force 90 N
- Automatic adaptation to valve
- Integrated temperature sensor and PI controller
- Temperature settings either on the device or via the app

Use

- The SSA911.01ZB wireless radiator valve actuator is designed to work on radiator valves of different manufacturers in HVAC applications using M30x1.5 thread. It operates the valve to control the water flow and controls the room temperature.
- The valve actuator works in combination with Connected Home Hub GTW100ZB and optionally with wireless repeater RCR110.2ZB.
- One Connected Home Hub GTW100ZB can be paired with up to 32 radiator valve actuators in parallel. Wireless repeaters RCR110.2ZB can be used to extend the range of the network.



Siemens Connected Home
(Application)

GTW100ZB

SSA911.01ZB

RCR110.2ZB

Basic functions

Function	Description
Communication	The communication protocol used is ZigBee. ZigBee is a low-power wireless mesh networking protocol and enables device-to-device and device-to-cloud communication. ZigBee is based on IEEE 802.15.4 radio standard.
Parallel operation	Up to 32 actuators can be paired and operated with 1 Connected Home Hub GTW100ZB.
Pairing	The pairing process is done via the mobile app Connected Home.
Calibration	The actuator automatically detects the end positions of the radiator valve.
Temperature setting	The setpoint temperature is set via the push buttons on the device.

Type summary

Type	Stock no.	Description
SSA911.01ZB	S55181-A103	Smart radiator valve actuator

Scope of delivery

- Radiator valve actuator SSA911.01ZB
- 2 AA alkaline batteries (LR6)
- Quick guide (A5W00205935A)
- Third-party valve adapter for Danfoss (RA, RAV, RAVL)

Equipment combinations

Siemens valves

The SSA911.01ZB is suited for use with the following types of Siemens radiator valves:

Type		k_{vs} [m ³ /h]	\dot{V} [l/h]	PN	Data sheet
VDN1.., VEN1..	Radiator valves	0.63...1.41	-	10	N2105
VDN2.., VEN2.., VUN2..					N2106
VD1..CLC..		1.9...2.6	N2103		
VPD.., VPE.., VPU..	MCV MiniCombiValves	-	10...135		A6V13089932
VD1.., VE1.. *	Radiator valves	0.25...3.4	-		N2145
VD2.., VE2.., VU2.. *					N2146

k_{vs} = Nominal flow rate of chilled water (5...30 °C) through the fully opened valve (H_{100}) at a differential pressure of 100 kPa (1 bar)

\dot{V} = Volumetric flow

* No longer available

Third-party valves without adapter

The SSA911.01ZB can operate third-party radiator valves without adapter, provided they have a M30x1.5 mm connecting thread and meet the following requirements:

Force 90 N nominal

Fully closed $x > 9.0$ mm

Fully open $y \leq 14.5$ mm

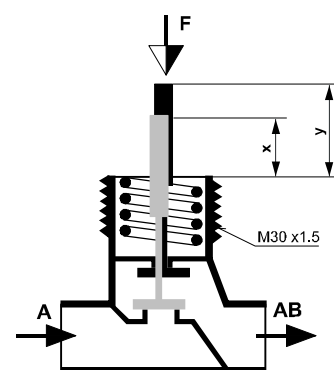

Valve pre-adjustment / k_v -limitation

For valve pre-adjustments, refer to the relevant technical documentation on the valves. Ensure a minimum valve stroke of > 0.5 mm.

Adapters for SSA911.01ZB for use with third-party valves				
Type	Stock no.	For use with...	Adapter thread	
AV52	BPZ:AV52	Comap	M28x1.5	
AV56	BPZ:AV56	Giacomini	-	
AV57	BPZ:AV57	Herz	M28x1.5	
AV58	BPZ:AV58	Oventrop < 2002	M30x1	
AV59	BPZ:AV59	Vaillant	-	
AV60	BPZ:AV60	TA < 2002	M28x1.5	
AV61	BPZ:AV561	MMA Markaryd	M28x1.5	

For information on adapters for other radiator valve types and manufacturers, contact your local office or branch.

Title	Contents	Document ID
Connected Home Radiator Valve Actuator ZigBee SSA911.01ZB	Data sheet: product description	A6V12789814
Quick guide Connected Home Radiator Actuator ZigBee SSA911.01ZB	Quick instructions for mounting, commissioning and operating SSA911.01ZB	A5W00205935A
Connected Home Hub GTW100ZB	Data sheet: product description	A6V12640776
Quick guide Connected Home Hub GTW100ZB	Quick instructions for mounting, commissioning and operating GTW100ZB	A6V12694180
Connected Home Receiver RCR110.2ZB	Data sheet: product description	A6V12680327
Quick guide Connected Home Receiver RCR110.2ZB	Quick instructions for mounting, commissioning and operating RCR110.2ZB	A6V11562443

Related documents such as environmental declarations, CE declarations, etc., can also be downloaded at the following Internet address:

www.siemens.com/bt/download

Notes

Security

	⚠ CAUTION
	<p>National safety regulations</p> <p>Failure to comply with national safety regulations may result in personal injury and property damage.</p> <ul style="list-style-type: none"> • Observe national provisions and comply with the appropriate safety regulations.

	⚠ WARNING
	<p>Burns from hot surface</p> <p>The screw nut with which the actuator is fastened on the radiator valve will become hot. Risk of burns from contact with the screw nut.</p> <p>When servicing the actuator:</p> <ul style="list-style-type: none"> • Switch off the radiator. • Allow the radiator to cool off.

	⚠WARNING
	<p>Explosion due to fire or short circuit, even with discharged batteries</p> <p>Risk of injury due to flying parts</p> <ul style="list-style-type: none"> • Prevent the batteries from coming into contact with water. • Do not recharge batteries. • Do not damage or disassemble batteries. • Do not expose batteries to temperatures over 85 °C.

	⚠WARNING
	<p>Leakage of electrolyte</p> <p>Severe burns</p> <ul style="list-style-type: none"> • Handle damaged batteries only wearing suitable protective gloves. • In case of contact with electrolyte, rinse eyes immediately with plenty of water. Consult a doctor.

Observe the following:

- Observe the polarities (+/-).
- The batteries must be new and undamaged.
- Do not mix new and used batteries.

Store, transport and dispose of the batteries in compliance with local requirements, regulations and laws. Also observe the instructions of the battery manufacturer.

Mounting

The SSA911.01ZB is mounted on the radiator valve. There are no preferred mounting positions; the actuator SSA911.01ZB may be operated in all mounting positions. Make sure the display is visible and the buttons are accessible.

	⚠WARNING
	<p>Falling objects</p> <p>Overhead installation may result in injury from falling objects.</p> <ul style="list-style-type: none"> • Do not install the actuator more than 2 m above ground.



Firmly tighten the screw nut by hand. No tools are required to tighten the actuator on the valve.

Commissioning







- Install the mobile application Connected Home.
 - The app provides a step-by-step guide through the commissioning process.
- Install and commission Connected Home Hub GTW100ZB (see also quick guide A6V12694180).
- Optional: Install and commission Connected Home Receiver RCR110.2ZB (see also quick guide A6V11562443).
- Install and commission Connected Home Radiator Valve SSA911.01ZB (see app, quick guide A5W00205935A).

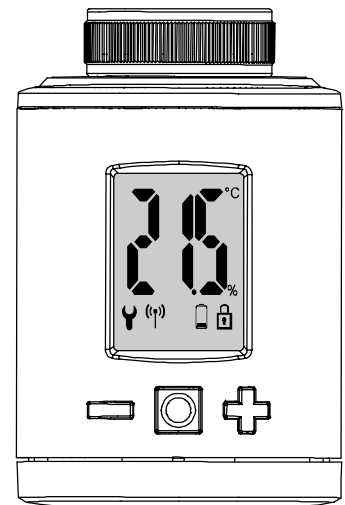





HMI

The interface consists of an LCD display and three push buttons.

-  Lower temperature
-  Okay (for task confirmation; with LED)
-  Raise temperature



Buttons				
	Press once		Lower room temperature by 0.5 °C.	
	Press and hold		Lower room temperature by 0.5 °C immediately, and lower by another 0.5 °C every 0.5 s while button is pressed; or until the lowest temperature is reached.	
	Press once		Raise room temperature by 0.5 °C.	
	Press and hold		Raise room temperature by 0.5 °C immediately, and raise by another 0.5 °C every 0.5 s while button is pressed; or until the highest temperature is reached.	
	Press once		Perform the displayed function.	
	LED	Red	Blinking	Update of controller software is being performed; no temperature regulation possible.
			Shining	Commissioning error.
	Green	Blinking	Waiting for confirmation by user (used to start tasks).	
		Shining (5 s)	Task successfully completed.	
		Press and hold together for 3 s	Activate or deactivate child safety lock.	
		Press and hold together for 10 s	After 10 s, a factory reset can be performed (display shows the duration the buttons are pressed). To perform the factory reset, the device must first be deleted from the device list in the Connected Home app.	

LCD Display	
	Lights up if mechanical tasks are ongoing.
	Displays radio connection and lights up during pairing.
	Low battery status – displayed when less than 15% battery is remaining.
	Displayed when child safety lock is active.
	Displayed continuously when LCD shows a setpoint temperatures.
	Displayed continuously when SSA911.01ZB is in direct control mode (instead of °C icon).
	Windows Open function is active. <ul style="list-style-type: none"> Function activates OFF mode for 15 min after a sudden drop in the room temperature. After 15 min, function stops OFF mode automatically and last active mode is restored. Function can be manually stopped by pressing the okay button.

Error codes

In case of an actuator malfunction or communication error with the Connected Home Hub, an error code is shown on the display of the SSA911.01ZB.

The error codes ER1-ER3 can be cleared by pressing the okay button.

Code	Error	Cause / Measures
ER1	No valve detected	<ul style="list-style-type: none"> Correctly mount the actuator on the radiator. Use the correct adapter.
ER2	Closing point not detected	
ER3	Valve movement not possible	<ul style="list-style-type: none"> Check if the valve pin is freely moveable.
ERR	Pairing failed	<ul style="list-style-type: none"> Device is not in pairing mode. Device is out of range.  <ul style="list-style-type: none"> Do not leave the actuator in error state "ERR" too long, as batteries will drain very fast. If error cannot be solved immediately, remove batteries and re-insert only when starting the pairing process again. If pairing fails multiple times, try a factory reset and restart the pairing process according to the documentation.

Maintenance

The SSA911.01ZB is maintenance free.

Disposal

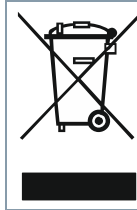

The device is considered an electronic device for disposal in accordance with European Directive and may not be disposed of as domestic waste.

- Use only designated channels for disposing the devices.
- Comply with all local and currently applicable laws and regulations.
- Dispose of empty batteries at designated collection points.

Warranty

Technical data on specific applications are valid only together with Siemens products listed under "Equipment combinations". Siemens rejects any and all warranties in the event that third-party products are used.

Radio equipment directive

The device is using harmonized frequency in Europe, and is also in compliance with the Radio Equipment Directive (2014/53/EU, formerly 1999/5/EC).

Cyber security disclaimer

Siemens provides a portfolio of products, solutions, systems and services that includes security functions that support the secure operation of plants, systems, machines and networks. In the field of Building Technologies, this includes building automation and control, fire safety, security management as well as physical security systems.

In order to protect plants, systems, machines and networks against cyber threats, it is necessary to implement – and continuously maintain – a holistic, state-of-the-art security concept. Siemens' portfolio only forms one element of such a concept.

You are responsible for preventing unauthorized access to your plants, systems, machines and networks which should only be connected to an enterprise network or the internet if and to the extent such a connection is necessary and only when appropriate security measures (e.g. firewalls and/or network segmentation) are in place. Additionally, Siemens' guidance on appropriate security measures should be taken into account. For additional information, please contact your Siemens sales representative or visit <https://www.siemens.com/global/en/home/company/topic-areas/future-of-manufacturing/industrial-security.html>.

Siemens' portfolio undergoes continuous development to make it more secure. Siemens strongly recommends that updates are applied as soon as they are available and that the latest versions are used. Use of versions that are no longer supported, and failure to apply the latest updates may increase your exposure to cyber threats. Siemens strongly recommends to comply with security advisories on the latest security threats, patches and other related measures, published, among others, under <https://www.siemens.com/cert/en/cert-security-advisories.htm>.

Technical data

Power supply	
Battery type	2 x alkaline batteries LR6 (AA) 1.5 V
Battery life	Ca. 2 years

Radio communication	
Frequency range	2.4...2.4385 GHz
Transmission power	<8 dBm
Range	≤ 30 m, depending on application and building
Protocol	ZigBee

Actuator	
Stroke	5 mm
Positioning force	typically 90 N
Noise level	EN ISO 3741 < 30 dBA

Built-in temperature sensor	
Measuring range	0...50 °C

Internal controller	
Type	PI

Degree of protection	
Protection class	Class III according to IEC 60730-1
Protection degree of housing	IP 20 ¹⁾ according to IEC 60529
Pollution degree	Class 2 according to IEC 60730

Environmental conditions		
Operation	Temperature	-20...54 °C
	Humidity (non-condensing)	65 % r.h. ± 20 %
Transportation	Temperature	-30...45 °C
	Humidity	65 % r.h. ± 20 %
Storage	Temperature	-30...45 °C
	Humidity	65 % r.h. ± 20 %
Medium temperature permissible in connected valve		1...70 °C

Directives and standards	
Product standard	IEC 60730-1
Electromagnetic compatibility (field of use)	For residential, commercial, and industrial environments
EU conformity (CE)	A5W00090263A ²⁾
EAC compliance	Eurasian compliance for SSA911.01ZB

Environmental compatibility
Product environmental declarations A6V13096860 ²⁾ include data on environmentally friendly product design and testing (RoHS compliance, material composition, packaging, environmental benefits, disposal).

Materials and Dimensions		
Display	LCD	
Housing	material	Plastic ASA+PC
	color	White NCS S 052-G
Thread	M30x1.5	
W x H x D	See Dimensions [▶ 12]	
Weight		

1) Completely mounted

2) Documents can be downloaded at <http://www.siemens.com/bt/download>

Dimensions

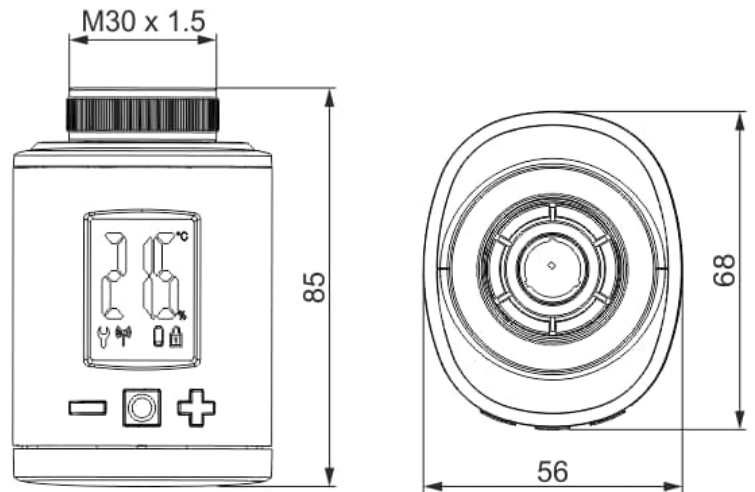

Dimensions in mm

	kg [kg]
Including batteries	0.176

Revision numbers

Type	Valid from rev. no.
SSA911.01ZB S55181-A103	..01